



DHV CONSULTANTS &
DELFT HYDRAULICS with
HALCROW, TAHAL, CES,
ORG & JPS

VOLUME 4
GEO-HYDROLOGY

DESIGN MANUAL

Table of Contents

1	INTRODUCTION	1
1.1	GENERAL	1
1.2	DEFINITION OF VARIABLES AND UNITS	1
1.3	GENERAL TERMS	2
1.4	CONVERSION TABLES	5
2	BASIC GROUNDWATER CONCEPTS	6
2.1	GROUNDWATER IN THE HYDROLOGIC CYCLE	6
2.2	GROUNDWATER CHARACTERISTICS	7
2.2.1	HYDRAULIC HEAD	7
2.2.2	DENSITY	8
2.2.3	DISSOLUTION CAPACITY	8
2.3	GROUNDWATER OCCURRENCE	8
2.3.1	UNSATURATED ZONE	9
2.3.2	SATURATED ZONE	9
2.4	HYDRAULIC CHARACTERISTICS OF GEOLOGICAL FORMATIONS	9
2.4.1	AQUIFER	9
2.4.2	AQUITARD	10
2.4.3	AQUICLUDE	10
2.4.4	AQUIFUGE	10
2.5	AQUIFER DEFINITIONS	10
2.5.1	CONFINED AQUIFER	10
2.5.2	SEMI-CONFINED AQUIFER	10
2.5.3	UNCONFINED AQUIFER	10
2.5.4	SEMI- UNCONFINED AQUIFER	11
2.6	PHYSICAL PROPERTIES OF AQUIFERS (AQUIFER PARAMETERS)	11
2.6.1	POROSITY (n)	11
2.6.2	HYDRAULIC CONDUCTIVITY (K)	13
2.6.3	TRANSMISSIVITY (T)	13
2.6.4	COEFFICIENT OF STORAGE OR STORATIVITY (S)	13
2.6.4	SPECIFIC YIELD (S_y)	14
2.6.5	HYDRAULIC DIFFUSSIVITY (T/S)	14
2.6.6	LEAKAGE COEFFICIENT OR LEAKANCE (L_c)	15
2.6.7	HYDRAULIC RESISTANCE (c)	15
2.6.8	LEAKAGE FACTOR (L)	15
2.7	GROUNDWATER MOVEMENT	16
2.7.1	DARCY'S LAW	16
2.7.2	GENERAL WATER FLOW	17
2.7.3	STEADY AND TRANSIENT FLOW	17
2.8	HYDROGEOLOGICAL CONDITIONS IS INDIA	17
3	ROLE OF MAPS IN GEO-HYDROLOGICAL INVESTIGATIONS	20
3.1	COMMON MAP SCALES	20
3.2	TOPOGRAPHIC MAPS	20
3.3	GEOLOGICAL MAPS	21
3.4	HYDROGEOLOGICAL MAPS	21
3.5	OTHER MAPS	22
4	GROUNDWATER MONITORING	23
4.1	CONCEPT OF MONITORING AND MONITORING NETWORKS	23
4.2	MONITORING CYCLE	23
4.3	WATER MANAGEMENT, INFORMATION NEEDS AND MONITORING STRATEGIES	26
4.4	NETWORK DESIGN AND OPERATION	27

4.4.1	GENERAL CONSIDERATIONS	27
4.4.2	THE NETWORK DENSITY AND LOCATION OF MEASURING POINTS	27
4.4.3	MONITORING PARAMETERS	28
4.4.4	TYPES OF MONITORING POINTS	29
4.4.5	MEASURING FREQUENCY	29
4.4.6	DATA COLLECTION	30
4.4.7	NETWORK SUSTAINABILITY	30
4.4.8	DUPLICATION AVOIDANCE	30
4.4.9	PERIODIC RE-EVALUATION	30
4.4.10	OPTIMISATION	31
4.5	CLASSIFICATION OF NETWORKS	31
4.6	NETWORKS DESIGNED FOR SPECIFIC OBJECTIVES	32
4.6.1	GROUNDWATER RESOURCES ASSESSMENT	32
4.6.2	SALINITY INGRESS	32
4.6.3	COMMAND AREAS	32
4.6.4	DROUGHT PRONE AREAS	32
4.6.5	ARTIFICIAL RECHARGE	32
4.7	SUMMARY OF THE NETWORK DESIGN PROCESS	33
5	WATER LEVEL MEASURING FREQUENCY	35
5.1	INTRODUCTION	35
5.2	PRESERVING THE HYDROGRAPH SHAPE	35
5.3	LENGTH OF WATER LEVEL DATA COLLECTION	36
5.4	CURRENT WATER LEVEL MEASURING FREQUENCY	37
5.5	PERIODIC MONITORING	37
5.6	CONTINUOUS MONITORING	38
5.7	MONITORING FREQUENCY FOR GROUNDWATER RESOURCE ESTIMATION	39
5.8	MONITORING FREQUENCY IN DROUGHT PRONE AREAS	40
5.9	MONITORING FREQUENCY IN IRRIGATED CANAL COMMANDS	41
5.10	MONITORING FREQUENCY IN OVER EXPLOITED AREAS	42
5.11	MONITORING FREQUENCY IN COASTAL AREAS	42
5.12	MONITORING FREQUENCY OF OTHER SUPPORTING HYDROLOGIC DATA	43
6	GROUNDWATER LEVEL MEASURING TECHNIQUES	44
6.1	MEASURING POINT	44
6.2	GROUNDWATER LEVEL MEASURING TOOLS	44
6.2.1	CHALCKED STEEL TAPE	45
6.2.2	ELECTRIC MEASURING TAPE	46
6.2.3	DIGITAL WATER LEVEL RECORDER	47
6.3	POTENTIAL INACCURACIES IN WATER-LEVEL MEASUREMENT	48
7	EQUIPMENT SPECIFICATIONS	49
7.1	INTRODUCTION	49
7.2	INSTRUMENT AND EQUIPMENT SPECIFICATIONS	49
7.3	OTHER ITEMS TO BE INCLUDED IN THE SPECIFICATIONS	50
7.4	INTERPRETATION OF EQUIPMENT SPECIFICATION	52
7.5	EVALUATION OF SPECIFICATIONS	52
7.6	INSTALLATION CRITERIA	54
8	DESIGN OF LITHO-SPECIFIC PIEZOMETERS	56
8.1	INTRODUCTION	56
8.2	CHARACTERISTICS OF GEOLOGICAL FORMATIONS	57
8.3	GROUNDWATER MONITORING IN INDIA- AN HISTORICAL PERSPECTIVE	58
8.4	MAINTENANCE OF PIEZOMETERS	59
9	REFERENCES	60

1 INTRODUCTION

1.1 GENERAL

The branch of earth science, which deals with the occurrence and movement of subterranean water is termed **Hydrogeology** (Mead 1919). It is the subdivision of the science of hydrology that deals with the water beneath the Earth's surface. It is interdisciplinary in scope in that it involves the application of the physical, biological and mathematical sciences. Because hydrogeology deals with the occurrence and movement of water in an almost infinitely complex subsurface geologic environment, it is, in its most advanced state, one of the most complex of the sciences. On the other hand, many of its basic principles and methods can be understood readily and used in the solution of ground-water problems. The relevance of the science of hydrogeology is becoming all the more relevant today especially in India, where overexploitation, declining Groundwater levels and Groundwater quality issues is affecting the lives of most of the population. Thus good understanding and successful application of this science by the practitioners is of critical importance to the welfare of mankind.

The term **Geo-Hydrology** was coined by Meinzer 1942 to describe in principle the same physical process. The term Geo-Hydrology is used in all the discussions in the manual.

The Volume 4 “Geo-Hydrology” of the “Manual on Hydrological Field Measurements and Data Processing”, consists of three parts:

1. Design Manual, in which the basic principles and procedures are put in context
2. Reference Manual, for details on specific topics
3. Field Manual, dealing with operational procedures at the observation stations

This part of Volume 4 covers the Design Manual: ‘Geo-hydrology’. It is set up as follows:

- Chapter 1 deals with definition of quantities and units, unit conversions.
- Basic principles relevant to physics of Groundwater flow are dealt with in Chapter 2.
- Chapter 3 deals with the design and optimisation of geo-hydrologic networks.
- Criteria for site selection of the monitoring stations are discussed in Chapter 4
- Chapter 5 deals with the monitoring frequency to be applied matching the measurement objectives.
- The measurement techniques for observation of water levels are dealt with in Chapter 6.
- The equipment specifications have been listed in Chapter 7. The equipment specifications proper are covered in a separate and regularly updated volume: “Groundwater Equipment Specifications”.
- Guidelines on piezometer design and installation are dealt with in Chapter 8.

In the Field Manual operational practices in running the network stations are given. It also includes field inspections, audits and last but not least, the topic of equipment maintenance and calibration.

1.2 DEFINITION OF VARIABLES AND UNITS

The use of standard methods is an important objective in the operation of the Hydrological Information System (HIS). Standard methods require the use of a coherent system of units with which variables and parameters are quantified. It is important to know the units of each quantity one is dealing with so as to see whether or not an equation is dimensionally correct. It has to be ensured that consistent set of units is used when doing calculations, which will help one to avoid a lot of mistakes. The standard

unit should be SI where the units of length (L), mass (M), and Time (T) are meters, kilograms, and seconds.

Quantity	Symbol	Unit
Linear Millimetre Centimetre Metre Kilometre		mm cm m km
Area Square centimetre Square meters Square Kilometres	A	cm ² m ² km ²
Volume Litre Cubic centimetre Cubic metre Million cubic metre		l cm ³ m ³ MCM
Discharge Litre per second Litre per minute Cubic metre per hour Cubic metre per day	Q	lps lpm m ³ /hr m ³ /d
Aquifer parameters Transmissivity Hydraulic Conductivity	T K	m ² /d m/d
Density Density of water Density of sediment, Relative density under water	ρ ρ_s $\Delta=(\rho_s-\rho)/\rho$	kg.m ⁻³ kg.m ⁻³ [-]
Pressure Air pressure Water pressure	p_a p	kPa kPa
Head Velocity head Pressure head Energy head	h_v h_p H_e	m m m

Table 1.1: Overview of relevant symbols and units used in geo-hydrology

1.3 GENERAL TERMS

Alluvial: Pertaining to or composed of alluvium or deposited by a stream or running water.

Igneous rocks: Rocks that solidified from molten or partly molten materials, that is from a magma or lava.

Sedimentary rocks: Clastic rocks resulting from the consolidation of loose sediments that has accumulated in layers or carbonate rocks originated from chemical precipitation and accumulation of organic matter.

Metamorphic rocks: Any rock derived from pre-existing rocks by mineralogical, chemical, and/or structural changes, essentially in the solid state, in response to marked changes in temperature, pressure, shearing stress, and chemical environment, generally at depth in the earth's crust.

Lithology: All the physical properties, the visible characteristics of mineral composition, structure, grain size etc. which give individuality to a rock.

Weathering: The in-situ physical disintegration and chemical de-composition of rock materials at or near the earth's surface.

Bed rock: A general term for hard massive compact rock that underlies the weathered and fractured rocks at depth.

Fracture: A break or crack in the bedrock.

Overburden: The layer of fragmental and unconsolidated material including loose soil, silt, sand and gravel overlying bedrock, which has been either transported from elsewhere or formed in place.

Fault: A fracture in the earth's crust along which dislocation has taken place so that the rocks on one side of the fault have been displaced in relation to those on the other side.

Marine deposits: Mostly silt and clay materials deposited under a marine environment.

Fluvial deposits: Deposits related to a river or stream.

Heterogeneous deposit: Non uniform structure and composition throughout the deposit.

Homogeneous deposit: Structure or composition of the deposit is uniform throughout.

Floodplain: The flat land adjacent to a river, formed by deposition of fluvial materials.

Aquifer: A formation or group formation or part of a formation that contains sufficient saturated permeable material to yield sufficient quantities of water to wells/springs.

Aquiclude: A geologic formation or part of a formation through which virtually no water moves.

Aquitard: A saturated but poorly permeable bed that does not yield water freely.

Perched Water: Unconfined groundwater separated from an underlying main body of groundwater by an unsaturated zone.

Piezometric head, [m]: The level to which water rises in a piezometer with a screen in a (semi)confined aquifer.

Piezometric surface: Imaginary surface defined by the elevation to which water will rise in wells penetrating confined aquifers.

Elevation/potential head, [m]: The height of any particle of water above a specified datum (potential energy per unit of weight relative to a horizontal datum)

Artesian well: A well obtaining its water from an artesian or confined aquifer in which the water level in the well rises above the top of the aquifer.

Flowing artesian well: A well where the water level is above the ground surface.

Hydraulic gradient: The rate of change in total head per unit of distance of flow in a given direction.

Equipotential lines: A contour line along which the pressure head of groundwater in an aquifer is the same.

Flow lines: Lines indicating the directions followed by groundwater to points of discharge.

Groundwater catchment area: An area contributing natural replenishment (recharge) of the groundwater regime. It may include localized discharge areas.

Groundwater divide: The uppermost boundary of a groundwater basin.

Recharge area (groundwater): An area where water infiltrates into the ground and joins the zone of saturation. In the recharge area, there is a downward component of hydraulic head.

Discharge area: An area where groundwater and water in the unsaturated zone is released to the ground surface, to surface water or to the atmosphere.

Base flow: The sustained low flow in a stream. Generally base flow is the inflow of groundwater to the stream.

Level of groundwater development: The level of groundwater use of an aquifer relative to the aquifer's ability to replenish itself.

Aquifer test: A test involving pumping a well and measuring the changes in head both during and after pumping.

Observation well: A well constructed for the objective of undertaking observations such as water levels, pressure readings and groundwater quality.

Piezometer: A tube with a screen as part of observation-well.

Pressure head, [m]: Height of liquid in a column corresponding to the weight of the liquid per unit area.

Drawdown: The variation in the water level in a well prior to commencement of pumping compared to the water level in the well while pumping. In flowing wells drawdown can be expressed as the lowering of the pressure level due to the discharge of well water.

Hydraulic head: The level to which water rises in a well with reference to a datum such as sea level.

Hydrograph: A graphical plot of changes in elevation of water or flow of water with respect to time.

Phreatic level: The free groundwater table where the pressure head is against the atmospheric pressure.

Radius of influence: The radial distance from a pumping well to the point where there is no drawdown of the water table or piezometric surface. This point marks the edge of the cone of depression around the pumping well.

Digital Water level recorder: A device which records automatically, either continuously or at frequent time intervals, the water level as sensed by a pressure transducer.

Fresh water-salt water transition zone: The interface zone occurring between fresh water and saltwater underlying marine islands and coastal areas with groundwater occurring below the surface of the ground in geologic formations under saturated conditions.

Filter Pack: Sand or gravel that is smooth, uniform, clean well rounded placed in the annulus of the borehole wall and the well screen to prevent formation materials to enter the screen.

Development: The act of repairing the damages to the formation caused by drilling.

Annulus: Space between the wall of the borehole and outer casing.

Stilling well: A well connected to the main stream in such a way as to permit the measurement of the stage in relatively still water.

1.4 CONVERSION TABLES

Multiply by to obtain:

Length		
inch	25.4	mm
feet	0.3048	m
yard	0.9144	m
mile	1.609	km
Area		
inch ²	6.4516	cm ²
feet ²	929.03	cm ²
yard ²	0.8361	m ²
mile ²	2.59	km ²
mile ²	259	ha
acre	0.40469	ha
Volume		
inch ³	16.3871	cm ³
feet ³	28.3168	l
yard ³	0.76455	m ³
Gallon US		
gal	3.78541	l
gal/min	6.309×10^{-2}	l/s
gal/min	5.451	m ³ /d
gal/d/ft ²	4.716×10^{-7}	m/s
gal/d/ft ²	4.075×10^{-2}	m/d
gal/d/ft	1.242×10^{-2}	m ² /d
gal/d/ft	1.437×10^{-7}	m ² /s
Gallon Imperial		
gal	4.54609	l
gal	1.2009	gal (US)
Flow		
ft ³ /s (cfs)	2.832×10^{-1}	l/s
l/s	15.85	gal(US)/min
l/s	13.20	gal(Imp)/min
m ³ /d	0.1835	gal(US)/min
m ³ /d	0.1528	gal(Imp)/min
l/s	3.531×10^{-2}	ft ³ /s (cfs)
Temperature		
deg. Fahrenheit	= $5/9 (^{\circ}\text{F} - 32)$	$^{\circ}\text{C}$
deg. Celsius	= $9/5 (^{\circ}\text{C} + 32)$	$^{\circ}\text{F}$

Table 1.1: Table showing standard conversion factors

2 BASIC GROUNDWATER CONCEPTS

2.1 GROUNDWATER IN THE HYDROLOGIC CYCLE

The term hydrologic cycle refers to the continuous movement of water above, on and below the earth's surface. The concept of the hydrologic cycle is central to an understanding of groundwater supplies. Although the hydrologic cycle has neither a beginning nor an end, it is convenient to discuss its principal features by starting with evaporation from vegetation, from exposed moist surfaces including the land surface and from the ocean. The sun warms the earth and oceans, causing water to evaporate and enter the air. Plants also release water into the air through a process called transpiration. As this moisture rises, it cools and condenses to form clouds. **Error! Unknown switch argument.** These clouds release water as precipitation in the form of rain, sleet, hail, and snow. This precipitation is partly intercepted in its downward movement before it falls on the surface from where part of it infiltrates or runs off, while the rest enter lakes and streams directly. All water on the land surface is surface water. Water that infiltrates, fills the space between particles of soil, sand, and rocks in the earth, thus forming groundwater. Groundwater, which flows very slowly, and surface water, which flows quickly, both move toward the oceans. Plants, animals, and people use some water and some is returned to the air through transpiration. The remainder returns to the oceans where it again evaporates to repeat the Hydrologic Cycle. A schematic representation of the hydrologic cycle is shown in Figure 2.1.

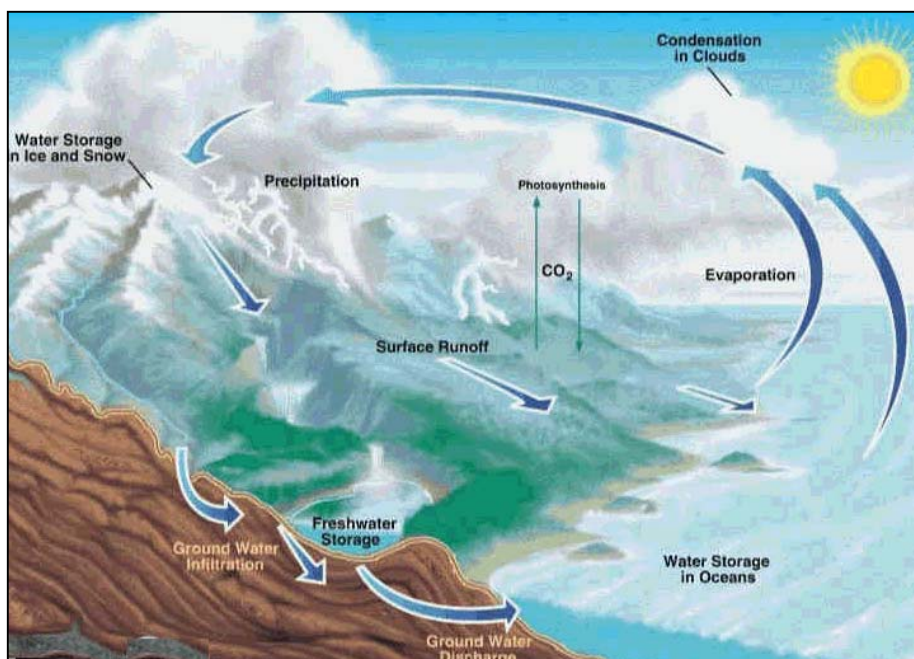

Figure 2.1: Hydrologic Cycle

Groundwater is in constant motion from a point of recharge to a point of discharge in accordance with the laws governing flow of fluids in porous media. The law of linear resistance gives the rate at which groundwater in motion loses energy. Further, because of addition and withdrawal from storage the volume of Groundwater in motion changes with distance according to the principle of conservation of mass. In general this can be expressed through equation of continuity

$$\text{Mass inflow rate} = \text{Mass outflow rate} + \text{Change of mass storage with time}$$

The rate of movement of groundwater depends on the type of subsurface rock materials in a given area. Saturated permeable formations like sands, gravel, weathered/fractured or structurally deformed hard rocks are favourable medium for groundwater flow. Impermeable formations like clays, shale, fines, silts and solid hard rocks do not offer/favour easy groundwater flow.

In areas where groundwater is used faster than it is naturally replenished, groundwater shortage is faced for small periods or continually depending upon the recharge rate. The categorisation of areas for groundwater development as recommended by Government of India (GEC-97 norms) suggests four categories, i.e. safe, semi critical, critical and over-exploited. The stage is defined as the ratio of the existing groundwater draft to the net annual groundwater availability. The net annual groundwater availability has been defined as the estimated resource minus a certain allowance for the natural groundwater discharge.

In certain areas groundwater is polluted by natural processes and the groundwater is contaminated with minerals like fluoride, arsenic, nitrate, etc, groundwater can be polluted by industrial effluents, landfills, septic tanks, leaky underground pipelines and from overuse of fertilizers and pesticides. When groundwater becomes polluted, it will no longer be safe to drink. The majority of the population in India in the urban areas and almost everyone who lives in rural areas uses groundwater for drinking water. The largest use for groundwater is to irrigate crops.

2.2 GROUNDWATER CHARACTERISTICS

2.2.1 HYDRAULIC HEAD

Groundwater has various physical characteristics such as velocity, density, temperature and energy state. The energy state determines among others the groundwater flow. The common approach used to express the energy state is to express the energy per unit weight. This yields the variable “hydraulic head” (h) expressed in the dimension L and in units of length (meters). The hydraulic head h at location z equals to:

$$h = z + \frac{p}{\rho g} \quad (2.1)$$

in which: ρ = density of water

g = acceleration of gravity

z = distance to a datum level

p = water pressure

The hydraulic head represents the height of water column above some arbitrary horizontal reference level to which the water will rise in a piezometer of an observation well.

The surface where the water pressure equals the atmospheric pressure is called **phreatic level** or **water table**.

The hydraulic head found under a semi-permeable layer (semi-confined aquifer) an impermeable layer (confined aquifer) is called **piezometric level** or **piezometric head**.

The water table is the boundary between the saturated zone and the unsaturated zone. The pressure head in the unsaturated zone is called the **suction head (Ψ)**. The suction head is negative relative to the atmospheric pressure.

The concept of hydraulic head is shown in Figure 2.2.

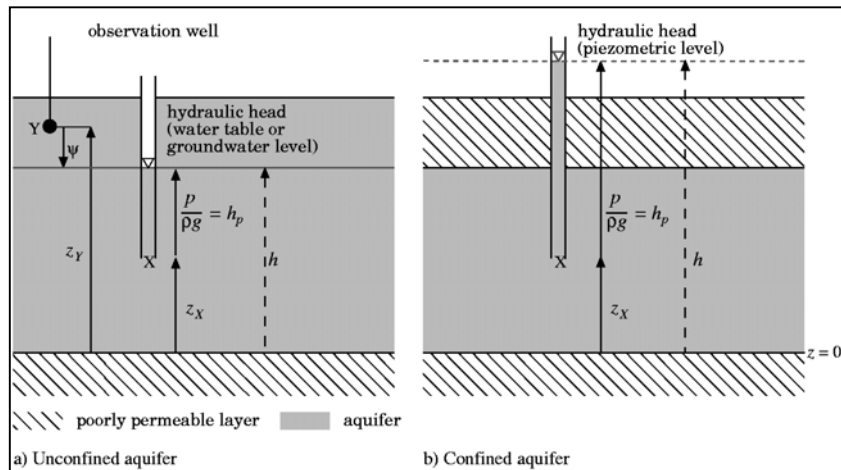

Figure 2.2: Schematic representation of hydraulic head (van Bracht, 2001)

2.2.2 DENSITY

The density of water is related to temperature. Water will have its greatest density, 1000 kg/m^3 , at $4 \text{ }^\circ\text{C}$. At other temperatures water will be lighter. Furthermore density is affected by the quantity of dissolved components. Saline water is heavier than fresh water. In many situations a layer of fresh groundwater may float upon more saline groundwater. In areas where groundwaters of different densities do exist, measurements of hydraulic head can only be used if the measured values are converted to an equivalent hydraulic head of equal density.

2.2.3 DISSOLUTION CAPACITY

Water is a very good solvent. Groundwater contains in general a great quantity of different substances in solution. Chemical compounds dissolved in water may have the form of molecules, but most are present in dissociated form as ions. The concentrations of dissolved compounds range from few micrograms/litre to several grams/litre. The composition of water reflects the composition of infiltrating water, interaction between water and rock, and eventual contamination from various pollution sources. The water quality is further discussed in Volume 6 of this manual.

Regarding the groundwater monitoring networks, data on groundwater composition are important in relation to the density variations and eventual clogging of monitoring wells.

2.3 GROUNDWATER OCCURRENCE

Groundwater in nature occurs in two different zones (see also Figure 2.3).

- Unsaturated zone, and
- Saturated zone.

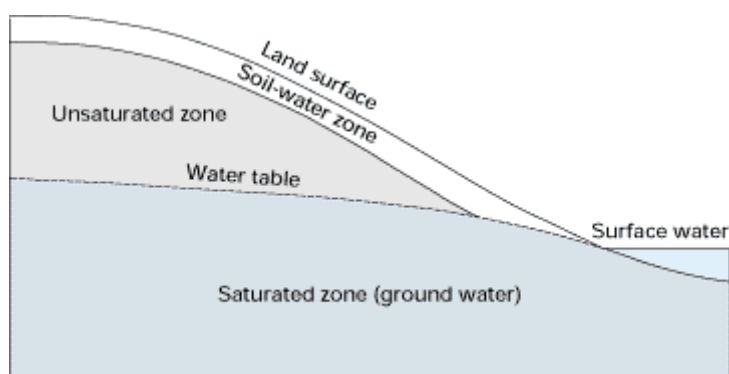

*Figure 2.3:
Generalised vertical section showing
the unsaturated and saturated zones
and the water table*

2.3.1 UNSATURATED ZONE

The unsaturated zone occurs immediately below the land surface in most areas and contains both water and air. In the unsaturated zone flow occurs beneath the land surface and above the groundwater table. The groundwater table forms the boundary between unsaturated subsurface flow (above it) and saturated subsurface flow (below it). In the unsaturated zone the preferred path of movement of moisture is vertical, by percolation, toward the saturated zone.

2.3.2 SATURATED ZONE

Water in the saturated zone is the only water under the surface that is available to supply wells and springs and is the only water to which the name groundwater is correctly applied. Recharge of the saturated zone occurs by percolation of water from the land surface through the unsaturated zone. The water table is the level in the saturated zone at which the hydraulic pressure is equal to the atmospheric pressure and is represented by the water table. Below the water table, the hydraulic pressure increases with increasing depth. In the saturated zone the preferred path of movement of moisture is horizontal, toward aquifer discharge areas. A generalised vertical section, showing the different zones, is presented in Figure 2.3.

2.4 HYDRAULIC CHARACTERISTICS OF GEOLOGICAL FORMATIONS

The geological formations based on their hydraulic properties are classified into:

- aquifer,
- aquitard,
- aquiclude, and
- aquifuge.

These are discussed below.

2.4.1 AQUIFER

An aquifer refers to a layer of rock or sediment that contains enough accessible water to be of interest to humans. An aquifer, from a commoner's point of view is a formation that can supply groundwater at rates, which is sufficient to meet domestic/ irrigation needs. Water in an aquifer is stored between the grains of rock. Aquifers have a relatively large permeability and the formation will be able to transmit appreciable quantities of groundwater. Aquifers can be either consolidated rock such as sandstone, basalt and granite or unconsolidated material, such as the sands and gravel.

2.4.2 AQUITARD

These are geological formations which have low to medium permeability and are able to transmit limited quantities of groundwater. These are usually formations with predominance of silt and clay. Aquitard retards groundwater flow and behave like semi-confining or impermeable leaky layers.

2.4.3 AQUICLUDE

An aquiclude is a geological formation with a very low permeability and the formation does not transmit any groundwater although it may contain groundwater. An aquiclude totally excludes groundwater flow. Aquicludes are also known as confining or impermeable layers.

2.4.4 AQUIFUGE

An aquifuge is a geological formation with low permeability and porosity. This does not transmit any groundwater and does not contain groundwater in appreciable quantities.

2.5 AQUIFER DEFINITIONS

Dependent on the permeability of the layers bordering the aquifer a distinction is made between:

- confined aquifer,
- semi-confined aquifer,
- unconfined aquifer, and
- semi-unconfined aquifer.

2.5.1 CONFINED AQUIFER

A confined aquifer is an aquifer in which groundwater is held under pressures greater than atmospheric pressure by upper and lower confining layers, forcing water to rise in wells to heights above the top of the aquifer (artesian wells). Also known as artesian aquifer. If the water level in an artesian well stands above the land surface, the well is a flowing artesian well. A particular aquifer at one place may be a confined aquifer but in other places may behave as an un-confined aquifer, when the water level falls below the base of the overlying confining layer. In the igneous and metamorphic rocks groundwater may occur in confined conditions in joints and fractures. In volcanic rocks e.g., the Deccan Traps, the interflow spaces and the vesicular beds form confined aquifers. In the Cuddalore sandstone of Tamil Nadu and in the Rajhamundry sandstone in Andhra Pradesh typical examples of flowing artesian wells are found in the hard rocks areas of South India.

2.5.2 SEMI-CONFINED AQUIFER

Semi-confined aquifers are aquifers situated between confining layers with a lower permeability. The upper (and lower) confining layers are semi-pervious, through which vertical leakage takes place due to head difference. These transmit limited quantities of groundwater. The proper direction of flow in a semi-confined aquifer is horizontal. The preferred direction of flow in the confining layers above and below is vertical.

2.5.3 UNCONFINED AQUIFER

An unconfined aquifer is not overlain by any confining layer but it has a confining layer at its bottom. It is normally partly saturated with water and the top of the saturated surface is known as the water

table, which is under atmospheric pressure. It is also known as a water table/phreatic aquifer. The water level in wells penetrating this aquifer indicates the position of the water table in the surrounding aquifer.

2.5.4 SEMI- UNCONFINED AQUIFER

Semi-unconfined aquifers are aquifers which exhibit characters in between semi-confined and unconfined aquifers as the permeability of the fine grained overlying layers is more than in a semi-confined aquifer and the horizontal flow component in it cannot be neglected.

Figure 2.4 shows the concept of an unconfined and a confined aquifer.

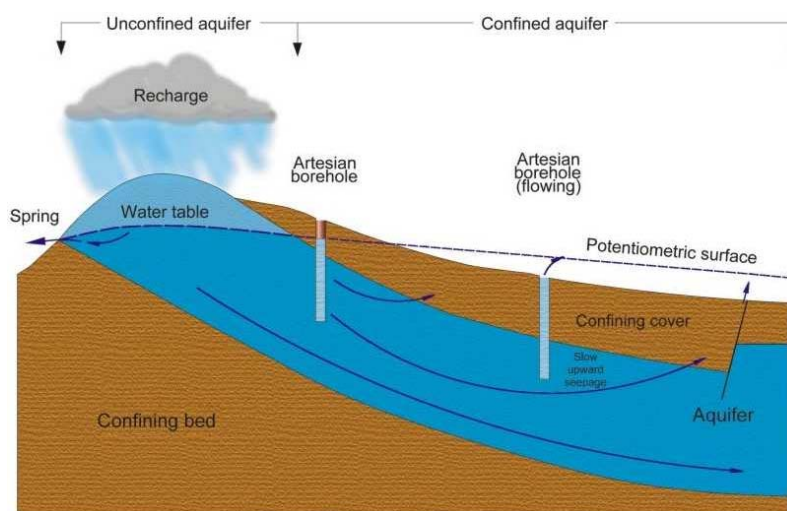

*Figure 2.4:
Cross-section sketch of a
typical ground-water-flow
system showing the relation
between an unconfined and
confined aquifer, a water table,
and other hydrologic elements.*

2.6 PHYSICAL PROPERTIES OF AQUIFERS (AQUIFER PARAMETERS)

In this section the following aquifer parameters are discussed:

- porosity,
- hydraulic conductivity,
- transmissivity,
- storativity,
- specific yield,
- hydraulic resistance, and
- leakage factor.

These are explained below.

2.6.1 POROSITY (n)

The bulk volume of rock includes the grains or crystals as well as the contained void space. The volumetric portion of bulk rock that is not occupied by grains, crystals or natural cementing material is termed porosity. Thus **porosity** n , is the ratio of void volume to the bulk volume (grains plus void space), see Figure 2.5 . Porosity is of two types: primary porosity and secondary porosity.

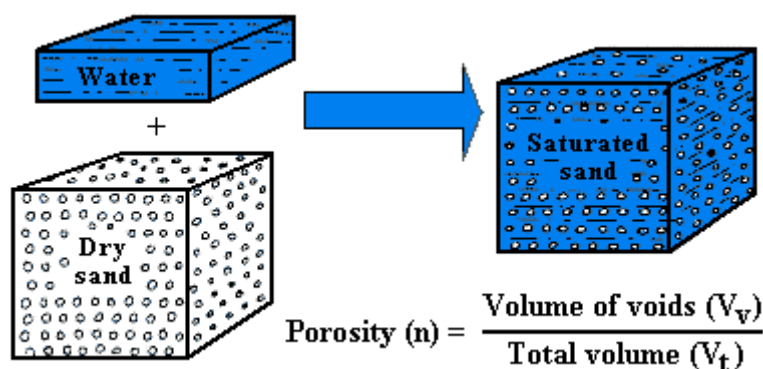

Figure 2.5: Visualisation of porosity in rocks

Primary porosity is the inherent characteristic that is developed during the formation of the rock, e.g. unconsolidated formations and sedimentary rocks have intergranular spaces. In basalts the primary porosity is due to gas cavities, the lava tubes and lava tunnels. The amount of pore space depends on the degree of compaction of the sediment (with compaction generally increasing with depth of burial), on the packing arrangement and shape of grains, on the amount of cementation, and on the degree of sorting. Typical cements are siliceous, calcareous or carbonate, or iron-bearing minerals. In consolidated rocks the openings are primarily present as fractures, at joints, along bedding planes and in the form of solution holes.

Secondary porosity is developed due to subsequent processes such as fracturing, jointing, and solution activities. In the igneous and metamorphic rocks as well as the hard sedimentary rocks the porosity is secondary in nature.

The **effective porosity** n_e is the volume of pores that is available for transport of water, divided by the bulk volume. The effective porosity is slightly less than the porosity as part of the water that is molecularly bound to the pores or is stored in dead end pores does not participate in the flow. Porosity is a non-dimensional number, which could range from 0-1, it is often reported as a percentage. In the fractured rocks the porosity depends upon the size of the individual fractures, joints and other openings.

Rock description	Range of porosity (n) in percentages	Range of hydraulic conductivity (K) in m/d
Gravel	0.2 – 0.4	10^2-10^3
Sand	0.2 – 0.5	$1-10^2$
Silt	0.3 – 0.5	$10^{-1}-1$
Clay	0.3 – 0.7	$10^{-8}-10^{-2}$
Fractured Basalt	0.05 – 0.5	$0-10^3$
Karst Limestone	0.05 – 0.5	$10^{-2}-1$
Limestone, Dolomite	0.0 – 0.2	10^{-2}
Shale	0.0 – 0.2	10^{-7}
Fractured Crystalline rocks	0.0 – 0.1	$0-10^2$
Dense Crystalline rocks	0.0 – 0.05	$<10^{-5}$

Table 2.1: Porosity and hydraulic conductivity range of some of the formations

Sedimentary rocks and soils generally have the highest porosities, mostly from primary, while secondary contributes in fracturing and dissolution. Igneous & metamorphic rock generally have low primary porosity, with sometimes-significant secondary porosity (fractures, especially in volcanic rocks). Rounded grains have smaller pore spaces between them in relation to irregularly shaped grains. Compaction results in reduction in porosity due to weight of overburden.

2.6.2 HYDRAULIC CONDUCTIVITY (K)

The hydraulic conductivity of permeability is the ease through which water is able to move through interconnected pore space, that forms an intricate net of irregular capillary tubes. The permeability depends on the properties of the medium (aquifer, aquitard and aquifuge) as well as those of water (fresh, salty, brine). The co-efficient of permeability is referred to as hydraulic conductivity and expressed as K. It has a dimension of velocity and is usually expressed in m/day. The hydraulic conductivity of fractured rocks depends largely on the density of the fractures and the width of their apertures. The orders of magnitude of hydraulic conductivity for different kinds of rock is given in Table 2.1 (based on Kruseman and de Ridder, 1990).

2.6.3 TRANSMISSIVITY (T)

The capacity of an aquifer to transmit groundwater is dependent upon the thickness and hydraulic conductivity. The term transmissivity is defined as the rate of flow water at the prevailing temperature under a unit hydraulic gradient through a vertical strip of the aquifer of unit width and extending through the entire saturated thickness of the aquifer. It is a product of average permeability and saturated thickness of the aquifer.

$$T = Kb \quad (2.2)$$

Where: T = transmissivity [m²/d]

K = hydraulic conductivity [m/d]

b = thickness of the aquifer [m]

The concept of transmissivity holds good in confined aquifer. In an unconfined aquifer, as the saturated thickness of the aquifer changes with time, the transmissivity will also change accordingly.

2.6.4 COEFFICIENT OF STORAGE OR STORATIVITY (S)

The storage coefficient in an aquifer is defined as the volume (V) of water that a vertical column of the aquifer of unit cross sectional area (A) releases from storage or takes into storage as the average head (h) within the column declines or rises a unit distance. It is dimensionless. In formula:

$$S = \frac{1}{A} \cdot \frac{dV_w}{dh} \quad (2.3)$$

In an artesian aquifer, which remains saturated throughout, changes in the pressure head reflect changes in the pressure exerted on the aquiclude and the resulting elastic changes in the aquifer. The water released from or taken into storage is accounted for by volume changes in the confined water and the aquifer system.

$$S = bS_s \quad (2.4)$$

where: S = storage coefficient [-]

b = thickness of the aquifer [m]

S_s = specific storage [m⁻¹]

The storage coefficient in artesian aquifers has the order of magnitude of 10⁻³ to 10⁻⁶.

2.6.4 SPECIFIC YIELD (S_y)

In unconfined aquifers the water is released by gravity drainage in proportion to the amount of decline of the water table. The coefficient of storage of the water table aquifers is the specific yield of the de-saturated material, given by:

$$S_w = S_y + bS_s \quad (2.5)$$

where: S_w = storage coefficient (water table aquifers) [-]

b = height of the water table above the impermeable layer [m]

S_y = specific yield of the aquifer [-]

Usually $S_y \gg bS_s$, thus S_w for all practical purposes is regarded as specific yield.

The specific yield is defined as the ratio of volume of water that a formation would yield by gravity to its own volume. Thus it effectively represents very closely the effective porosity. Table 2.2 gives some representative values of specific yield used in India. The coefficient of storage of the water table aquifer is expressed as a percentage 0.01= 1%. When the values of the coefficient of storage and fluctuations of the water table or piezometric surface (Δh) are known, the quantity of water added or released from the aquifer (ΔV) can be calculated as:

$$\Delta V = S_w \Delta h \quad (2.6)$$

Formation		Recommended	Maximum	Minimum
Alluvium	Sandy	0.16	0.2	0.12
	Silty	0.1	0.12	0.08
	Clayey	0.06	0.08	0.04
Hard Rock	Karstified Limestone	0.08	0.15	0.05
	Sand Stone	0.03	0.05	0.01
	Weathered Granite, Gneiss, Schist with low clay	0.03	0.04	0.02
	Laterite	0.025	0.03	0.02
	Lime Stone	0.02	0.03	0.01
	Weathered/Vesicular Jointed Basalt	0.02	0.03	0.01
	Weathered Granite, Gneiss, Schist with significant clay	0.015	0.02	0.01
	Quartzite	0.015	0.02	0.01
	Phyllite, Shale	0.015	0.02	0.01
	Massive poorly fractured rock	0.003	0.005	.002

Table 2.2: Specific yield range of some of the formations

2.6.5 HYDRAULIC DIFFUSIVITY (T/S)

The ratio of transmissivity to the coefficient of storage (T/S) of an aquifer is defined as its hydraulic diffusivity. This parameter determines the time that is needed for a given head change to occur in an aquifer in response to greater change in head at another point. It is the rate of propagation of change in head in an aquifer and is given by:

$$D = \frac{T}{S} = \frac{K}{S_s} \quad (2.7)$$

where D = hydraulic diffusivity [m^2/d]

For unconfined conditions the hydraulic diffusivity term is directly proportional to transmissivity of the aquifer obtained as the product of the hydraulic conductivity of the water bearing material and the average saturated thickness of the unconfined aquifer. The diffusivity of unconfined aquifer will be:

$$D = \frac{T}{S_y} = \frac{K \cdot b}{S_y} \quad (2.8)$$

2.6.6 LEAKAGE COEFFICIENT OR LEAKANCE (L_c)

The leakage coefficient is a measure for the vertical conductivity of a semi-confining layer. It is the ratio of vertical permeability of the semi-confining layer to its thickness. It has dimension of $[T^{-1}]$

$$L_c = \frac{K'}{b'} \quad (2.9)$$

where: K' = hydraulic conductivity of aquitard for vertical flow [m/d]

b' = thickness of the aquitard [m].

2.6.7 HYDRAULIC RESISTANCE (c)

The hydraulic resistance (c) is the reciprocal of the leakage coefficient and expresses the resistance against vertical flow. It is a property of confining layers of leaky aquifers and is defined by:

$$c = \frac{b'}{K'} \quad (2.10)$$

It characterises the resistance of a semi-pervious layer to upward or downward leakage. It has the dimension of time and it is often expressed in days. Values of c vary from some hundreds of days to several ten thousand days. For aquicludes, c is infinite. If the hydraulic resistance $c = \infty$, the aquifer is confined.

2.6.8 LEAKAGE FACTOR (L)

The leakage factor is defined by:

$$L = \sqrt{T \cdot c} = \sqrt{\frac{T \cdot b'}{K'}} \quad (2.11)$$

It determines the distribution of leakage into the leaky semi-confined aquifer. A high value of L indicates a great resistance of the semi-pervious strata to flow. The factor L has the dimensions of length and is usually expressed in metres.

2.7 GROUNDWATER MOVEMENT

2.7.1 DARCY'S LAW

Quantitative studies of the movement of water in aquifers led to the formulation of mathematical statements. The foundation for quantitative work in the field of Groundwater flow was developed in 1856 by the French engineer Henri Darcy. Darcy was a water-supply engineer interested in improving filter sands for water purification. He measured Q , volumetric flow rate, cross sectional area A , length of sand column ΔL , and difference in water-level readings $\Delta\Phi = \Phi_1 - \Phi_2$. The change in water levels divided by distance between measurements $\Delta\Phi/\Delta L$ is the hydraulic gradient. Darcy found that the velocity of flow through porous media is proportional to the head loss.

The relationship found by Darcy can be expressed as:

$$\frac{Q}{A} \cong q = K \frac{\Delta\phi}{\Delta L} \quad (2.12)$$

where q is the specific discharge and has dimensions of volumetric flow rate per unit area, $[L/T] =$ velocity. K is a proportionality constant, the hydraulic conductivity, and has dimensions of velocity also. Note also that $\Delta\Phi/\Delta L$ is often written as i , so:

$$q = Ki \quad (2.13)$$

When the length ΔL becomes infinitesimally small, we may replace the difference with a differential. Given a functional description of the spatial changes in water elevations, we may calculate the hydraulic gradient at a single point using differential calculus:

$$q = -K \frac{d\phi}{dL} \quad (2.14)$$

Note the negative sign: the flow is in a direction opposite to the (mathematical) hydraulic gradient.

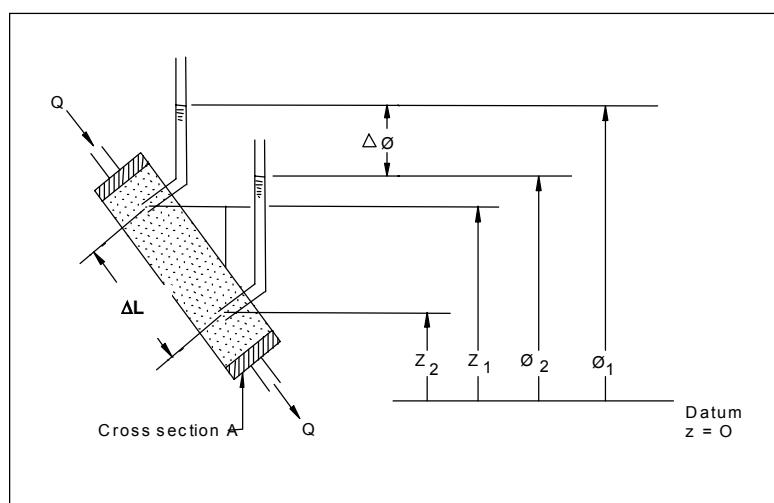

Figure 2.6: The Darcy laboratory set-up (Source: Freeze & Cherry, 1979)

2.7.2 GENERAL WATER FLOW

The groundwater system as a whole is actually a three-dimensional flow field, therefore, it is important to understand how the vertical components of ground-water movement affect the interaction of groundwater and surface water. A vertical section of a flow field, shown in Figure 2.7, indicates how potential energy is distributed beneath the water table in the ground-water system and how the energy distribution can be used to determine vertical components of flow near a surface-water body. The term hydraulic head, which is the sum of elevation head and water pressure divided by the weight density of water, is used to describe potential energy in groundwater flow systems. Water that infiltrates at land surface moves vertically downward to the water table to become groundwater. The groundwater then moves both vertically and laterally within the ground-water system. Movement is downward and lateral on the right side of the diagram, mostly lateral in the center, and lateral and upward on the left side of the diagram.

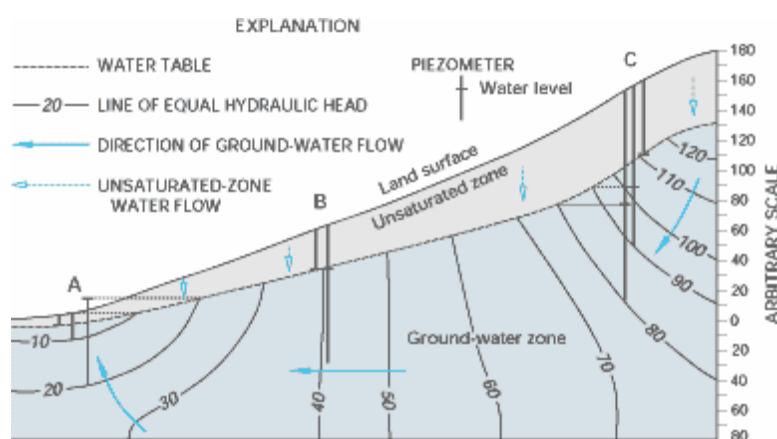

Figure 2.7:
Generalized vertical section of
subsurface water flow.

2.7.3 STEADY AND TRANSIENT FLOW

If at any specific point within the flow medium the velocity of flow is constant at all times (magnitude and direction) the flow is said to be in steady or in steady state conditions. When the groundwater level does not change the natural flow is steady. During the recharge phase or during pumping of the aquifer the equilibrium suffers an imbalance and result in transient condition or unsteady state of flow, where velocity of flow at specific point changes in magnitude and/or direction with time. When an aquifer is pumped the steady natural flow will be disturbed and the flow towards the well will change over time and develop transient condition of flow. When the piezometer is pumped for long, a state of equilibrium is ultimately reached (leakage/recharge) and the steady flow will prevail. In such case the steady state represents a theoretically ultimate condition (time = ∞) as a special case of transient state.

2.8 HYDROGEOLOGICAL CONDITIONS IS INDIA

The Peninsular India is a vast region with diversified geological, climatological and topographic set up, giving rise to varying Groundwater situations. The rock formations range in age from Archean to Recent, and are widely varied in composition terrain's of the Eastern and Western Ghats to the flat alluvial plains of the river valleys and coastal tracts. The topography and rainfall control runoff and groundwater recharge to a large extent.

Almost the entire Peninsula is occupied by a variety of hard and fissured formations, including crystalline, trappean basalt and consolidated sedimentaries (including carbonate rocks), with patches of semi-consolidated sediments in narrow intra-cratonic basins. Rugged topography, compact and fissured nature of the rock formations, combine to give rise to discontinuous aquifers, with moderate to poor yield potentials. The near surface weathered mantle, forms an important groundwater

reservoir and is a source for circulation of groundwater through the underlying fracture systems. In the hard rock terrain, deep weathered pediments, lowlands, valleys and abandoned river channels, generally contain adequate thickness of porous material, to sustain groundwater development. Figure 2.8 gives the generalised geological framework of Peninsular India.

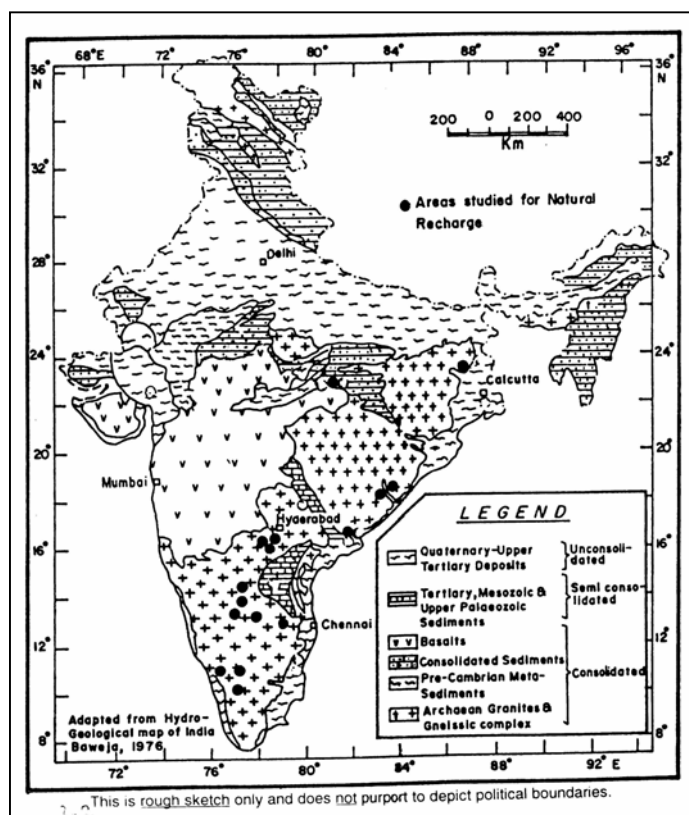

Figure 2.8:
Generalised geological framework of India.

Rock types are classified as 'consolidated' or as 'unconsolidated' types. The consolidated types are referred to as 'hard rocks'. These rocks are composed of individual minerals which are fused together and can not be separated from each other. The unconsolidated rock types or 'soft rocks' are made up of loose materials consisting of separated minerals. Consolidated rocks include granites, basalt, gneiss, sandstone, shale, limestone, quartzite etc. Unconsolidated rocks include sands, silt, gravel, clays and loams etc.

Consolidated and Fissured Formations

In consolidated rocks the water bearing zones do not have primary porosity but only have secondary porosity. The aquifers are the weathered zone. This apart fractures, joints, bedding planes, and solution holes host the aquifers. These openings do not have an even distribution, but are rather localised phenomena.

From the hydrogeological point of view, the consolidated rocks cover over a wide stretch of Peninsular India and are broadly classified into the following groups:

- Crystalline rocks

The major suits of crystalline basement rocks of Peninsular India are of Pre-Cambrian age. The predominant lithological types are granite gneisses and high grade metamorphic rocks like charnockites, granodiorites and khondalites. These rocks on prolonged weathering, has resulted in the formation of the weathered mantle. The relative depth and degree of weathering depends on the mineral grain size of the crystalline rocks, their intensity of fracturing and the relative proportion of Fe-Mg minerals. The weathered zone is underlain by unweathered rock, fractured rock followed by bedrock. The depth of the bed rock varies from 30-100 m.

- Volcanic rocks

The 'basic' type of volcanic rock are the basalts. The basalts form alternate layers of compact and vesicular beds of lava flows. The lava flows are mostly horizontal, but occasionally, are very gently dipping. The groundwater occurrence in the basalts are controlled by nature and extent of weathering, presence of vesicles and lava tubes, thickness, number of flows and the nature of inter-trappean layers. The basalts have usually medium to low permeabilities. Groundwater occurrence in the Deccan Traps is controlled by the contrasting water bearing properties of different flow units, thus, giving rise to multiple aquifer system, at places. The water bearing zones are the weathered and fractured zones.

- Semi-consolidated formations

The semi-consolidated formations belong to the group of rocks ranging in age from Carboniferous to Mio-Pliocene. These are mainly composed of shale, sandstone, and limestones formations. The terrestrial freshwater deposits belonging to Gondwana System of the peninsular shield are included under this category. The Gondwana sandstones form highly potential aquifers, locally. Elsewhere, they have moderate potential and in places they yield meagre supplies. These sediments normally occur in narrow valleys or structurally faulted basins. Though these formations have been identified to possess moderate yield potential, the physiography of the terrain restricts exploitation. Under favourable situations, these sedimentaries give rise to flowing well conditions as in parts of Godavari valley, Vellar basin, Cambay basin and parts of westcoast.

- Sedimentary rocks

The sedimentary rocks include carbonate rocks such as limestones, dolomite and marble. Among the carbonate rocks, limestones have the greatest distribution. In the carbonate rocks the principal aquifers are the fractured zone and solution cavities. Solution cavities develop due to circulation of water. This process leads to widely contrasting permeability within short distances.

Consolidated sedimentary rocks occur in Cuddapah and Vindhyan subgroups and their equivalents. The formations consist of conglomerates, sandstones, shales, slates, quartzites, apart from the limestones/dolomites. Locally, they contain phyllites and schists. The Cuddapahs and their equivalents were subjected to low grade metamorphism in places while the Vindhyan and their equivalents do not show any evidence of metamorphism. The occurrence and movement of water in them is governed by bedding planes, cleavages, fractures, joints, faults, contact zones, degree and magnitude of weathering, topography and climate. When interbedded with clay, sandstones can form a multi aquifer system. In case of dipping formations, piezometers located along dip direction may tap different aquifers, thus giving rise to artesian conditions along dip slopes. Also, at any given location, the altitude of piezometric head usually increases in the lower aquifers. The clastic formations possess higher porosity and permeability than the crystalline rocks due to its intergranular porosity, though limited due to cementation and fracture systems. As a result, they yield up to moderate quantities of water under favourable conditions. However, their porosity decreases with depth due to compaction. Piezometers sites in these formations have to carefully selected keeping in kind the structural controls.

- Porous Formations

Unconsolidated formations

The Quaternary sediments in the coastal and deltaic tracts bordering the peninsular and coastal alluvium form important reservoirs of groundwater. The horizons of sand and their admixture form potential aquifers. The aquifer materials vary in particle size and rounding and in their degree of sorting. Consequently, their water yielding capabilities vary considerably. The coastal aquifers show wide variation in the water quality, both laterally and vertically, thus imposing quality constraints for groundwater development. Thus, in these tracts, groundwater withdrawal requires to be regulated so as not to exceed recharge and in order to avoid sea water ingress into coastal aquifers. Sites for piezometer location can be readily identified in these formations.

3 ROLE OF MAPS IN GEO-HYDROLOGICAL INVESTIGATIONS

Geo-hydrological investigations involve understanding of the area through the use of maps. Different types of maps have to be referred by the geo-hydrologists and these include the topographic maps, geological maps, hydrogeological maps, drainage map, soil map, land use map and integrated groundwater resource potential map constructed by overlaying the different themes. In all the studies original printed maps have to be preferred rather than the photocopies, as they are likely to be distorted. The topographic map, the geological map and hydrogeological maps pertaining to the area of investigation are the important reference maps. It is expected that all the different varieties of maps are available in the respective field offices. The maps are to be carried to the field site during field investigation. The field staffs have to be proficient in reading and interpreting the different maps.

3.1 COMMON MAP SCALES

For regional investigations the topographic map of 1:250,000 scale will be ideal for understanding the regional physiography as well as the drainage basin characteristics. For field investigation, maps of 1:50,000 or even higher scale should be preferred. Printed geological and hydrogeological maps are available in 1:250,000 scale and 50,000 scale are available for large parts of the country. These maps are the basic tools for field hydrogeologists. Good understanding of the different maps and ability to interpret them in the field is the fundamental requirement of field training.

Metric Ratio	Distance on the map
1: 1000,000	1cm=10 km
1: 250,000	1cm=2.5 km
1: 125,000	1cm=1.25 km
1: 50,000	1cm=500 m
1: 25,000	1cm=250 m
1: 10,000	1cm=100 m

3.2 TOPOGRAPHIC MAPS

The topographic maps display the distinctive characteristic of the shape of the land surface shown by contour lines. The features that can be easily picked up from the topographic map are vegetation (green), drainage (black & blue) water bodies (blue), roads and tracks (red and black), contours (brown), habitations (red). Various point symbols are used to depict features such as buildings, springs, water tanks, mines, survey control points, and wells. Interpreting the coloured lines, areas, and other symbols is the first step in using topographic maps. Features are shown as points, lines, or areas, depending on their size and extent. Post offices, temples, churches, mosques, hospitals and other landmarks are shown as distinctive symbols. Names of places and features also are shown in a colour corresponding to the type of feature.

Topographic contours are shown in brown by lines of different widths. Each contour is a line of equal elevation; therefore, contours never cross. They show the general shape of the terrain. To help the user determine elevations, index contours (usually every fourth or fifth contour) are wider. Spot heights are shown at prominent points. The narrower intermediate and supplementary contours found between the index contours help to show more details of the land surface shape. Contours that are very close together represent steep slopes. Widely spaced contour or absences of contours, means that the ground slope is relatively level. The elevation difference between adjacent contour lines, called the contour interval, is selected to best show the general shape of the terrain. Elevation values are shown at frequent intervals on the index contour lines to facilitate their identification, as well as to enable the user to interpolate the values of adjacent contours.

The field hydrogeologists should be able to orient the map properly locate his/her position correctly as well as read the geographical co-ordinates of the observation wells/piezometers. Use of photocopy of

the topo-sheets should not be resorted to as the map scales will be distorted and the geographical co-ordinates will be erroneous. Delineation of watershed boundaries using the drainage features should be useful in understanding of the groundwater monitoring structure with respect to recharge/discharge or runoff zone.

3.3 GEOLOGICAL MAPS

A geologic map shows the distribution of geologic features, including different kinds of rocks and structural features like faults, folds, shear zones etc. A geologic map is usually generated on top of a regular base map. The base map is printed with light colours, so it doesn't interfere with seeing the geologic features on the map. The geology is represented by colours, lines, and special symbols unique to geologic maps. Understanding these features will allow one to understand much of the geology shown in almost any standard geologic map.

The most striking features of geologic maps are its colours. Each colour represents a typical geologic unit, a certain kind of rock of a given age range. So sandstone of one age might be coloured bright orange, while sandstone of a different age might be coloured pale brown. In addition to colour, each geologic unit is assigned a set of letters to symbolise it on the map. Usually the symbol is the combination of an initial capital letter followed by one or more small letters.

The contacts of different geologic units are represented by different kinds of lines as depositional contacts or faults. Tilted beds are shown on a geological map with a strike and dip symbol. The symbol consists of three parts: a long line, a short line, and a number. The long line is called the strike line, and shows the direction in the bed. The short line is called the dip line, and shows which way the bed is tilted. The number is called the dip, and shows how much the bed is tilted, in degrees, from flat. The higher the number, the steeper the tilting of the bed, all the way up to 90 degrees if the bed is tilted all the way onto its side.

All geologic maps come with a legend where all the colours and symbols are shown and explained. The legend starts with the youngest units with short description of the kinds of rocks in that unit and their age. All the different types of lines on the map are explained, and the different strike and dip symbols. Because the geology in every area is different, the legend is vital to understanding the geologic map.

3.4 HYDROGEOLOGICAL MAPS

The hydrogeological map enables various areas to be distinguished according to their hydrologic characteristics with respect to geology. The map depicts groundwater resources on a base map showing geology and topography. They provide essential information on the aquifers, their extension, boundaries, their lithology, and the depth to water level. Hydrogeological maps are outcome of detailed regional investigations, which provide sufficient information in understanding the hydrogeological characteristics of the area, the potential aquifers, their depth, thickness, groundwater discharge rates, and quality category. Vertical illustrations are used to depict the aquifers, potentiometric surface and ground surface showing the vertical sections separately from the horizontal. Hydrogeological maps are available for different areas and should be used wherever available.

The hydrogeology is represented by colours, lines, and special symbols unique to hydrogeologic maps. The extensively productive inter-granular aquifers are shown in blue colour, the fissured aquifers in green, and strata with no groundwater in brown. Signs and symbols are given in several colours for groundwater source and springs (violet), groundwater quality (orange), and stratigraphic symbols (black).

These maps also show one or more aquifer parameters such as transmissivity. Groundwater resource assessment figures are also occasionally represented.

3.5 OTHER MAPS

In addition to the classical geological and hydrogeological maps are hydrochemical maps, which indicate the chemical characteristics of groundwater. This map gives an idea as to how groundwater gets modified either by natural processes or due to mans interventions. Different classes of groundwater quality are assigned different colours.

Isopach maps show thickness of formations. These maps, wherever, available are useful for identifying potential locations for drilling piezometers.

Satellite images also provide complementary information on geological formations and structures. Aerial photographs may also be available for specific areas, which can also be referred to before field investigations.

4 GROUNDWATER MONITORING

4.1 CONCEPT OF MONITORING AND MONITORING NETWORKS

Groundwater monitoring as defined by UN/ECE Task Force on Monitoring and Assessment, (1999) is the collection of data, generally at set locations and depths and at regular time intervals in order to provide information which may be used:

- to determine the state of groundwater both in quantitative and qualitative sense
- to provide the basis for detecting trends in space and time, and
- to enable the establishment of cause-effect relationships.

A groundwater monitoring network is a system of dedicated ground water monitoring wells in a geo-hydrological unit at which ground water levels and water quality are measured at pre-determined frequency.

The identification of the monitoring objectives is the first step in the design and optimisation of the monitoring systems. Related to this is the identification of the potential data users and their future needs. Reference is made to Chapter 3 of Volume 1, Textbook (?) on Hydrological Information System for a summary. The actual data need for a particular area is to be obtained by interviewing the potential hydrological data users, to be presented in a Hydrological Information Need (HIN) document, where in case of more objectives, priorities are indicated.

The second variable to be considered in the design of the geo-hydrological network is the dynamics of the system in time and space. This requires a critical analysis of historical data.

This volume deals with monitoring of groundwater quantity. Water quality monitoring is discussed in Volume 6.

4.2 MONITORING CYCLE

A monitoring cycle is a sequence of related activities that starts with the definition of information needs and ends with the use of information products. A schematic representation of the monitoring cycle for groundwater is given in Figure 4.1.

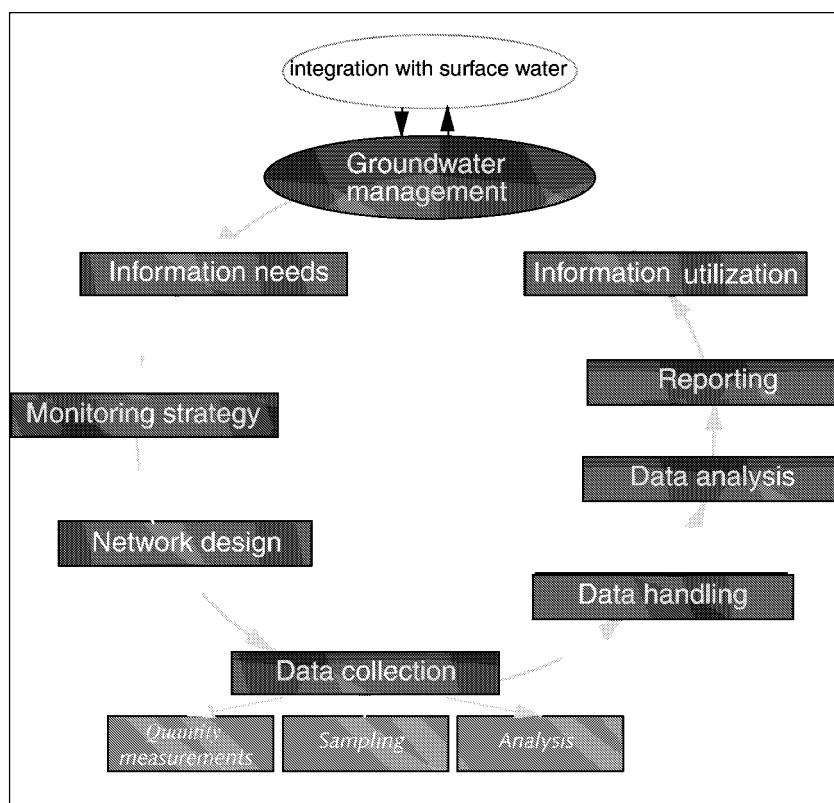

Figure 4.1: The Monitoring Cycle (source: UN/ECE TFMA, 1999)

A detailed description of all steps in a monitoring cycle is presented in documents of UN/ECE Task Force on Monitoring and Assessment (UN/ECE TFMA 1999 and 2000). The following summary is based on these documents.

(1) Water management

The need for information should be based on the main issues or problems in management of water, and the active use of information in the decision-making process. Water management should consider the functions/use of a water system, the problems and threats to the water system and the possible measures that can be taken to manage the water system.

(2) Information needs

The design of a monitoring system depends on the information, which is required for the execution of proper groundwater resources management. The information needs should be assessed on the basis of the management objectives, which should be translated into technical monitoring objectives for which the required monitoring efforts (e.g. measurements and data analysis) should be defined.

(3) Monitoring strategy

A monitoring strategy defines the approach and the criteria needed for a proper design of the monitoring program. Defining the strategy is aimed at optimising the use of available technical, legal, financial and human resources to meet the information requirements.

(4) Network design and establishment

Once the technical objectives have been established and specific strategies have been developed for the respective monitoring programme, each strategy can be linked to a monitoring network design. The design of monitoring networks includes the determination of:

- the network density and location of measuring points,
- monitoring parameters
- types of monitoring points, and
- the measuring and sampling frequency.

The design is primarily a function of the selection of sampling-point type, density and location, sampling method and frequency and the choice of parameters. However, an appropriate design also considers the necessary activities for the establishment of the network stations, the technical design of the measurement points and the materials used and further the operational procedures for the measurement and data handling. After the design has been completed, the system has to be established. In case of new network stations, the points of observation have to be selected in the field according to the criteria set. Drilling and installation activities should meet criteria to ensure proper execution of the works and use of proper materials in order to establish an observation point which is representative for the particular situation defined for the design of the network. Furthermore, the organisations responsible for the maintenance and operation of the network and for the data handling should be made operative.

(5) Data collection

Operation of the monitoring system involves the implementation of the designed procedures, the execution of the measurements and the maintenance procedures according to the objectives and criteria set. This step includes all field activities and it results in the production of the raw data.

(6) Data processing

Data processing after the production of the raw data is included in the computerised GEMS (Groundwater Estimation and Monitoring System). The data processing with GEMS also includes the data validation.

(7) Data analysis

In this step, the collected data have to be analysed, keeping in mind the information needs and objectives of the monitoring programme (as defined in step 2). Data analysis should provide information (i.e. transform data to information) which is relevant to the water managers who need the information. In the Hydrology Project, data analysis will take place with the computer software GEMS.

(8) Reporting

In this step, the results of the data analysis are reported to the water managers and other who want and need the water quality information. Reporting is typically done via a written report, but can also be presented by a newsletter, or electronically (with Internet), or as a presentation.

(9) Data storage

Field and validated data are to be distinct moments in time transferred to the database in the Data Storage Centre.

(10) Information utilisation

Finally, the information produced will be used by the user groups and the groundwater management authorities. The acquired information should be compared with the expectations and the standards and when necessary management measures have to be taken or changed.

Communication to the general public for raising general awareness is important to get support for the measures taken.

This volume deals with Steps 1-5 of the monitoring cycle in general, with focus on 4 and 5 in particular.

4.3 WATER MANAGEMENT, INFORMATION NEEDS AND MONITORING STRATEGIES

The basic water management issues regarding groundwater quantity include:

- proper assessment of groundwater resources, and
- protection of available resources from overexploitation.

Changes in water quantity influence the groundwater movement and consequently the potential transport of various contaminants.

Specific issues encountered in India include:

- salt water intrusion in the coastal areas,
- rising of groundwater levels in irrigated areas,
- declining of groundwater levels and reduced discharge in drought prone areas, and
- impact of artificial recharge.

Information needs include:

- the spatial and temporal variations of groundwater levels,
- information on hydraulic properties of aquifers, and
- quantification of the groundwater recharge component in the water balance.

Since with most agencies a ground water monitoring network is already functional, the network design process is one of evaluation, review and update of the existing network. The historic evolution of the ground water monitoring networks has tended to be reactive rather than strategically planned. Often monitoring stations are being operated for which the original objectives are unclear. It is therefore necessary to regularly undertake a detailed review of the existing networks to achieve the following:

- define and/or re-define the purpose of each monitoring station;
- identify gaps in the existing network;
- identify monitoring stations which need to be replaced or abandoned;
- establish a framework for the continual evaluation and updating of the network.

There is a tendency for geo-hydrologists and water resources planners to be reluctant to discontinue monitoring stations, even though they might have fulfilled their intended objectives and are no more relevant. In the design and evaluation of networks it is essential that a 'hard nosed' approach is adopted and stations which are no longer providing a significant benefit are discontinued.

The monitoring network of all the different agencies involved with ground water monitoring within a unit area should be integrated. Integration of monitoring networks would necessarily call for transparency in data collection, validation and data exchange. The layout of the monitoring stations of the different agencies should be guided by logistical convenience while avoiding duplications and reducing wasteful expenditure.

4.4 NETWORK DESIGN AND OPERATION

4.4.1 GENERAL CONSIDERATIONS

The design of an optimal network layout should reflect the entire hydrogeological system of the area under consideration. The network should provide long term information on the different aquifers being developed. Information on shallow aquifers tapped by open wells, deeper multi-layer aquifers tapped through open dug wells/dug cum borewell/borewell/tube wells and ground water development issues (declining water levels, rising water levels, coastal salinity, water logging in irrigated areas, ground water pollution etc) should be considered in the network design.

A minimum network should include a number of ground water monitoring stations in the recharge area, run off and discharge area, for each of the aquifer system within the considered drainage/administrative units. Since the ground water monitoring networks are of particular socio-economic importance to the State and country, it is essential that all problems related to drinking water, irrigation, health and industrial demands of ground water are prioritised during the network design. It has to be kept in mind that the overall objective of the monitoring network is for understanding the dynamics of the ground water system, trends in ground water fluctuation so as to assess the total ground water resource within the reservoir that can be safely harnessed. Other requirements of the network are for understanding the ground water dynamics, flow patterns, recharge-discharge relationship etc.

Data requirement and availability of budget should guide the network density and frequency of monitoring. It has to be always remembered, that the establishment of monitoring stations is less expensive as compared to the long-term cost of regular data collection and maintenance and regular upgrading of the monitoring station. Authentic data can emerge only from networks, which are not starved of funds nor have shortfall of manpower.

The design of a network may have two extreme points of departure. Firstly, a design of a network may start almost from scratch, without or with a few available historical groundwater monitoring data and consequently, the hydrogeological approach will be the basis of the design procedure. Secondly, a design of a network might start with the availability of sufficient historical monitoring data. In that case and if the target parameters can be sufficiently quantified, the design can be considered as an optimisation problem and might be fully supported by statistical considerations.

4.4.2 THE NETWORK DENSITY AND LOCATION OF MEASURING POINTS

Decisions made about the number and locations of observation wells and piezometers are crucial to any water-level data collection program. Ideally, the sites chosen for an observation well network will provide data representative of various topographic, geologic, climatic, and land-use environments. Decisions about the areal distribution and depth of completion of piezometers also should consider the physical boundaries and geologic complexity of aquifers under study. Water-level monitoring programs for complex, multilayer aquifer systems may require measurements in nested piezometers

completed at multiple depths in different geologic units. Large, regional aquifers that extend beyond State/basin boundaries require a network of observation wells distributed among one or more States. If one of the purposes of a network is to monitor ambient ground-water conditions, or the effects of natural, climatic-induced hydrologic stresses, the observation network will require dedicated piezometers that are unaffected by pumping, irrigation, and land uses that affect ground-water recharge.

The basic principles for the location of monitoring wells can be summarised as follows:

- The location of the observation monitoring wells in terms of sites, depth, design (single or nests) should be based on geo-hydrological, social and economical considerations. Optimal design should include assessment of the density of the network through statistical algorithms which needs to be adjusted based on geo-hydrological conditions and monitoring objectives.
- The site selection for locating monitoring stations should be largely guided by local area conditions. The site selection should ensure that data collected should be unbiased and not subjected to interference from production wells, canals or surface water bodies in the neighbourhood.
- Round the year accessibility and foolproof protection to the monitoring station and the monitoring equipment's should be considered during site selection.

4.4.3 MONITORING PARAMETERS

(a) Parameters related to monitoring water quantity

Quantified parameters which can be measured directly during the monitoring include:

- water level measurements within an observation well,
- discharge of abstractions and springs,
- induced recharge (disposal of effluent, infiltration of surface water for purification and storage of drinking water etc.), and
- leakage of distribution and sewerage systems.

For interpretation of above data and for balancing recharge, storage and discharge of the groundwater resources, data will be needed on:

- the surface water system (levels and flows) and its interaction with groundwater (discharge/recharge); in particular base flow of rivers and streams,
- the climatological conditions (e.g. precipitation, evapotranspiration), and
- soil moisture.

Principally, there is no difference between the type of quantity parameters to be measured in the complex groundwater flow systems of consolidated, indurated formations, which are entirely or partly linked to the occurrence of joints, fractures and/or voids and the groundwater flow systems in unconsolidated sediments with intergranular porous permeability. However, the evaluation of the results will be more difficult for the hard rock formations, which will generally need more additional information (e.g. geology).

(b) Parameters related to groundwater quality

The quality parameters include a wide range of inorganic and organic compounds. Some of the parameters can be measured directly in the field, but the majority require laboratory analyses. Parameters related to groundwater quality are discussed in detail in Volume 6 on Water Quality Sampling.

Temperature measurements and total dissolved solid contents measurements (related to EC) are important for the determination of water density and subsequently the correction of water level measurements.

Occasionally the chemical data are needed to evaluate the cause of clogging of monitoring wells.

4.4.4 TYPES OF MONITORING POINTS

Four types of monitoring wells may be distinguished:

- shallow wells,
- abandoned deep wells,
- observation wells with one piezometer, and
- observation wells with nested piezometers.

The use of existing wells for monitoring requires special arrangements regarding the gathering of information on the lithology, depth of screens and pumping regime.

An observation well (piezometer) is a well specially designed for the monitoring purposes.

These need to be of small diameter, sufficient enough to accommodate the water level measuring device and the water-sampling pump. In unconsolidated formations, piezometers are to be provided with screens, tapping the zone of interest; whereas in the consolidated rocks, piezometers need to be left open ended (uncased) beneath the loose soil/loose over-burden where the hole has to be provided with a casing. The piezometer construction procedure should follow standard procedures with incorporation of site-specific elements as described in the Field Manual Volume 4, Part 2.

4.4.5 MEASURING FREQUENCY

Ground water level monitoring should help record the major changes taking place in the ground water reservoir at different points of time. The frequency of water-level measurements is among the most important components of a water-level monitoring program. Although often influenced by economic considerations, the frequency of measurements should be determined to the extent possible with regard to the anticipated variability of water-level fluctuations in the monitoring well and the data resolution or amount of detail needed to fully characterise the hydrologic behaviour of the aquifer. The frequency of measurement should be such that all the significant changes that take place in the reservoir is continuously recorded. The measurement should be able to discriminate between the short-term and the seasonal ground-water-level fluctuations of interest and the long-term hydrologic changes.

The monitoring frequency should be so adjusted to pick up the annual cycle and other cycles of shorter duration like seasonal, barometric, daily, tidal etc as required.

Definition of monitoring frequency for routine and advanced studies: Routine monitoring for the assessment of water storage fluctuations may be satisfied by as little as four measurements annually and may benefit from a daily figure. On the other hand, depletion curve analyses, tidal and barometric efficiency calculations and correlation with hydro-meteorological features used to calculate aquifer parameters, require much higher frequencies, approaching, in certain cases, almost continuous monitoring. Such frequencies have been reported (but not entirely proven) to yield even early warning signals, moments before major earthquakes.

For determining the measuring frequency the intended use of the data and the length of water level data collection needs to be understood.

The water level measuring frequency, with emphasis on the situation in India is further elaborated in Chapter 5 of this Volume.

Measurements of other parameters such as well discharge and chemical composition is subject to requirements defined for specific objectives of monitoring.

4.4.6 DATA COLLECTION

Several measuring techniques are currently in use for groundwater level records. Basically these are divided into:

- Manual measurements using various tapes to record the groundwater depth related to a fixed point at the surface.
- Automatic measurements, based on “pressure transducers”, allowing digital measurements at variable intervals.

Groundwater level measuring techniques are further discussed in Chapter 6 of this Volume.

Techniques for discharge measurements are described in Field Manual Volume 4, Part III on aquifer testing. Direct measurements of physical parameters and collection of samples for chemical analysis are described in Volume 6 on water quality sampling.

Protocols for data collection are needed and to be followed to guarantee the required quality of the obtained information. The collected field data, recorded in a pre-defined format should be transferred as soon as possible to the agency responsible for data storage and management.

4.4.7 NETWORK SUSTAINABILITY

Of paramount importance is sustainability. It is a relatively straightforward task to design a dense network of ground water monitoring stations. However, the implementation and operation of a network is a lot more difficult. It has been found from experience that there is a tendency to adopt an idealistic approach and attempt to have as many monitoring stations as possible. There are many examples of networks throughout the world, which are no longer functioning well due to lack of financial support, skilled manpower and logistic support resources such as vehicles. It is far better to operate and maintain a limited number of monitoring stations than to operate and maintain a large number of poorly maintained stations i.e. reliable data from fewer stations is preferable to unreliable data from a greater number of stations.

4.4.8 DUPLICATION AVOIDANCE

Since generally, more than one organisation is responsible for the establishment of monitoring stations e.g. the State Ground Water Departments and CGWB, **it is essential that the activities are co-ordinated so that they complement each other and duplication of efforts is avoided.**

4.4.9 PERIODIC RE-EVALUATION

Ground water monitoring station networks require **periodic re-evaluation**. The developments that take place in the basin, like construction of new irrigation wells, urbanisation, industrialisation of the area, may warrant addition or replacement of abandoned wells. For example, in many areas hand

dug open wells have gone into disuse and are not used for tapping the groundwater. However, the dug well still continues to be a monitoring structure. In such wells the water level/quality data emerging have proved to be a source of embarrassment to the agency because of the wrong information they provide. Therefore there is a need for replacing the abandoned wells with new wells or construction of dedicated piezometers.

4.4.10 OPTIMISATION

At a number of locations no stations will be available. Hence, the information is to be obtained from the network by e.g. interpolation. If the interpolation error in estimation is too large then additional stations or a re-design should be considered. Statistical techniques are most applicable to already well established networks, where the data have been rigorously quality controlled and are readily available in computer compatible form. However, they are less readily applied to over-exploited areas, where the population of groundwater wells is increasing rapidly. These techniques are a tool to assist in the network design. They are not straightforward to apply and do not totally obviate the need for the pragmatic, common sense approach.

4.5 CLASSIFICATION OF NETWORKS

The concept of representative networks for administrative units has been established in the states, however optimisation of the network should be based on hydrogeological/drainage units. This would be particularly relevant for ground water resource estimation.

The following classification of monitoring networks is introduced:

- **Regional network:** This network should cover the entire major hydrogeological and ground water development units met within the region/state under consideration. These networks should be made up of key observation sites, which represent typical hydrogeological phenomena and have large aerial representation. The monitoring well of this network should be monitored for a long period of time. The network density is such that water level data is available for estimating the ground water resource availability of major administrative units/drainage basins.
- **State network:** This network should supplement the regional network. In this network the density of monitoring wells shall be high with special coverage to get a fair representation of the diverse hydrogeological and drainage units within a state. The monitoring in this network should be continued for long periods with high frequency of monitoring. The network density is such, that adequate coverage is available for estimating the ground water resource availability of small administrative units / watersheds.
- **Local network:** This network need to be established specifically for studying local problems within localised areas. These networks are established during specific special/R&D studies. The monitoring stations need to be operated for the limited period of time, during the period of study. Typical problem areas that have a local network are for monitoring freshwater/salt water interface in coastal areas, study of land subsidence, assessment of ground water in untapped areas, earthquake affected areas etc.

Dependent on the user's need for information, three basis classes of monitoring can be distinguished:

- Monitoring networks for the benefit of water users; these networks are often directly related to economic considerations.
- Monitoring networks for the benefit of scientific studies; these networks focus on e.g. calibration of groundwater models.
- Monitoring networks for the benefit of water management; these networks focus on collecting information to realise the most effective and efficient water management possible.

It is obvious that various “mixes” of these types of use exist.

4.6 NETWORKS DESIGNED FOR SPECIFIC OBJECTIVES

4.6.1 GROUNDWATER RESOURCES ASSESSMENT

The network for ground water assessment should cover all major administrative and drainage units in the different states. The monitoring wells should cover all the representative hydrogeological units within the administrative/drainage units. The monitoring wells/piezometers in the network should have good hydraulic connection with the ground water reservoir it represents and should respond truthfully to all changes to system with minimum lag time. In areas where more than one aquifer is available cluster/nested piezometers should be constructed and incorporated into the network. There should be an adequate number of monitoring wells within each drainage unit so as to provide accurate information on the ground water levels in the recharge, discharge and runoff zone.

4.6.2 SALINITY INGRESS

Ingress of seawater leading to contamination of the ground water resources is an emerging problem in many of the coastal states in India. This problem is reaching alarming levels in certain cities. The sea water ingress needs to be closely monitored through exclusive networks, totally focussed on the coastal salinity problem.

A dense monitoring network should be established from the recharge area to the outflow region upto the coast with the aim of picking up the localised groundwater gradients.

4.6.3 COMMAND AREAS

Surface water irrigated areas are showing problems related to rising of water levels in irrigated areas leading to water logging. The Groundwater system, which is a beneficiary of the recharge from surface irrigation, responds through rising water levels. The rising trend in water levels needs to be checked through suitable groundwater development. The recharge response from the surface irrigation needs to be monitored in all the command areas through exclusive ground water monitoring networks. The aim of the monitoring network should be to closely understand the surface water-ground water interplay. The monitoring network has to be very dense in the canal commands and its periphery. The monitoring has to be for long periods of time. It is preferable to set up exclusive ground water monitoring networks in the irrigation projects right at the design stage itself.

4.6.4 DROUGHT PRONE AREAS

Droughts have become very common for large areas of the country. The main impact of the drought has been on the ground water system resulting in lowering of water levels and reduced discharge from the wells. Ground water monitoring of the drought prone areas should be essentially for quantifying the ground water resource availability in the different aquifers so as to manage them efficiently during the droughts as well as design structures for enhancing the ground water recharge during rains/floods. Dedicated network for drought monitoring is required for understanding the rainfall-recharge relationship, delineation the different hydraulic compartments, studies impact of overdrafts, etc.

4.6.5 ARTIFICIAL RECHARGE

Programmes for initiating artificial recharge has been taken up with heavy investment through out the country as watershed management, rain water harvesting, tank desiltation, etc. Ground water monitoring networks need to be established for assessing the impact of these programmes.

4.7 SUMMARY OF THE NETWORK DESIGN PROCESS

The monitoring network is one of the most important tools for the assessment, exploitation and protection of the groundwater resources.

The technical basis of a network consists of a number of observation wells which are either existing wells or are purposely designed piezometers tapping the groundwater body which has to be monitored. The design of a monitoring network is a part of the monitoring cycle, which starts with a request for information and ends with the use of information for various purposes. A generalised scheme, showing the position of the design and implementation process of a monitoring network in relation to the monitoring cycle is depicted in Figure 4.2.

Numbers between parentheses refer to the steps in the monitoring cycle described in section 4.1.

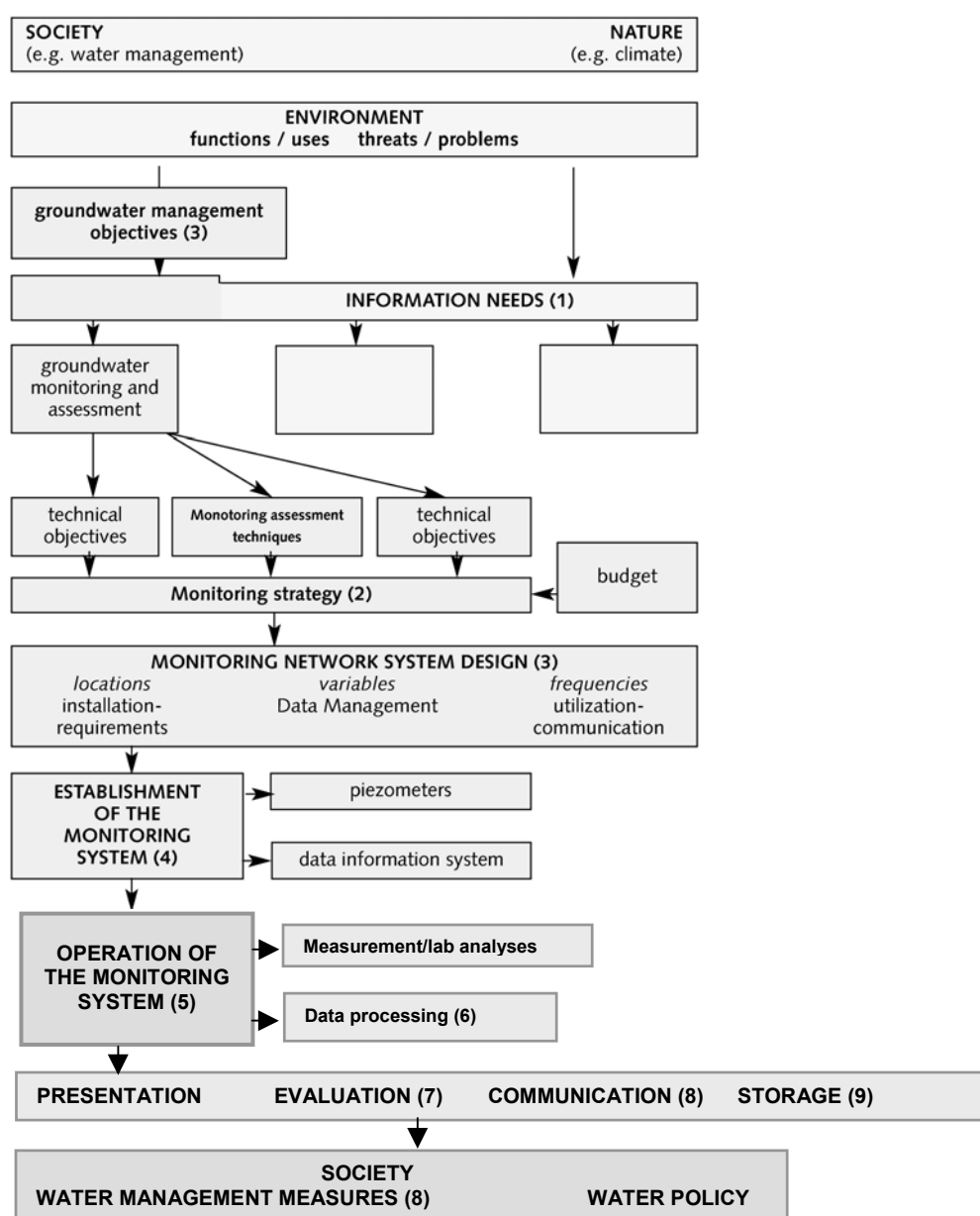

Figure 4.2: Design and implementation process of a monitoring network for groundwater (Adopted from: UN/ECE Task Force on Monitoring and Assessment, 1999).

The main steps in the network design process can be summarised as follows:

1. define the purposes and objectives of the network,
2. review available information,
3. evaluate and optimise the existing network,
4. estimate overall costs of implementation, operation and maintenance,
5. prepare a phased implementation plan,
6. select the appropriated sites for observation wells, and
7. establish framework for regular periodic maintenance.

The above steps are further elaborated in the Volume 4, Field Manual Part I.

As the groundwater monitoring network design is a dynamic process, networks have to be continually reviewed and updated so that they react to new priorities, changes in policies and fiscal changes. Regular formalised network reviews should be undertaken, recommended to take place after 3 years or at a shorter interval if new data needs do develop.

5 WATER LEVEL MEASURING FREQUENCY

5.1 INTRODUCTION

Groundwater level monitoring should help record the major changes taking place in the groundwater reservoir at different points of time. The frequency of water-level measurements is among the most important components of a water-level monitoring program. Although often influenced by economic considerations, the frequency of measurements should be determined to the extent possible with regard to the anticipated variability of water-level fluctuations in the monitoring well and the data resolution or amount of detail needed to fully characterise the hydrologic behaviour of the aquifer. The frequency of measurement should be such that all the significant changes that take place in the reservoir are continuously recorded. The measurements should be able to discriminate between the short-term and seasonal ground-water-level fluctuations of interest and the long-term hydrologic changes.

Water levels measurements are carried out for a number of reasons including:

- estimating the average piezometric head,
- understanding the groundwater regime,
- computing groundwater resource availability,
- design of groundwater management structures,
- Identify the short term changes due to pumping, tidal effects, isostatic changes, earth tides, etc.,
- Ground-water investigations.

To achieve the above objectives one or more of the following attributes have to be estimated from the monitored water level data after generating the water level hydrograph.

- peak of the hydrograph,
- trough of the hydrograph,
- time of shallow water level, i.e., time during which the water level rises above a stipulated shallow critical level,
- time of deep water level, i.e., time during which the water levels falls below a stipulated deep critical level,
- rate of rise or decline, and
- response time after an event.

The water level hydrograph may be statistically analysed to desire properties on trends and time dependent variations. Such analysis provides information in the long-term change of the groundwater levels and the seasonal periodicity.

5.2 PRESERVING THE HYDROGRAPH SHAPE

The groundwater reservoir shows rising and falling water levels, which are a response to a number of phenomenon, many of which may be periodic (that is, self repeating). Each periodic phenomenon imparts a periodicity to the water level hydrograph in the form of cycles displaying rising water levels followed by recession, which appears in the hydrograph as a sinusoidal wave, having its own parameters such as wavelength (time period), amplitude and starting point.

The duration of these cycles is different in different situations. The monitoring frequency should be so adjusted to be able to pick up the annual cycle and other cycles of shorter duration like seasonal, barometric, daily, tidal, etc., as required.

Thus, the criteria would be to arrive at such monitoring frequency that the desired attribute(s) as derived from the observed hydrograph is (are) close enough to the true values (i.e., the values derived from the true hydrograph). The selected monitoring interval should be such that the monitored hydrograph resembles closely with the true hydrograph. This should be the most stringent and all-encompassing expectation while deciding the monitoring frequency. The monitoring intervals would depend upon the degree of the desired resemblance so as to ensure a high enough correlation between the true and the monitored hydrograph.

5.3 LENGTH OF WATER LEVEL DATA COLLECTION

For determining the measuring frequency, the intended use of the data and the length of water level data collection needs to be understood. Water-level data need to be collected over various lengths of time, dependent on their intended use(s). Short-term water level data are collected over periods of days, weeks, or months during many types of groundwater investigations. For example, tests done to determine the hydraulic properties of wells or aquifers typically involve the collection of short-term data. Water level measurements needed to map the altitude of the water table or potentiometric surface of an aquifer, are generally collected within the shortest possible period of time so that hydraulic heads in the aquifer are measured under the same hydrologic conditions. Usually, water-level data intended for this use are collected over a period of days or weeks, depending on the logistics of making measurements at different observation-well locations.

Long-term data are fundamental to the resolution of many of the most complex problems dealing with ground-water availability and sustainability. Significant periods of time years to decades typically are required to collect water-level data needed to assess the effects of climate variability, to monitor the effects of regional aquifer development, or to obtain data sufficient for analysis of water-level trends

Many of the applications of long-term water-level data should involve the use of analytical and numerical (computer) ground-water models. Water-level measurements serve as primary data required for calibration and testing of ground-water models, and it is often not until development of these models that the limitations of existing water-level data are fully recognized. Furthermore, enhanced understanding of the ground-water-flow system and data limitations identified by calibrating ground-water models provide insights into the most critical needs for collection of future water-level data. The uses and importance of long-term water-level data are more fully realised by examining actual case studies.

Intended use of water-level data	Typical length of data-collection effort or hydrologic record required			
	Days/weeks	Months	Years	Decades
To determine the hydraulic properties of aquifers (aquifer tests)	✓			
Mapping the altitude of the water table or potentiometric surface	Error! Error! Unknown switch argument.✓	Error! Error! Unknown switch argument		
Monitoring short-term changes in ground-water recharge and storage	Error! Error! Unknown switch argument.✓	✓	Error! Error! Unknown switch argument.	
Monitoring long-term changes in ground-water recharge and storage			Error! Error! Unknown switch argument.✓	✓
Monitoring the effects of climatic variability			Error! Error! Unknown switch argument.✓	✓
Monitoring regional effects of ground-water development			Error! Error! Unknown switch argument.✓	✓
Statistical analysis of water-level trends			Error! Error! Unknown switch argument.✓	✓
Monitoring changes in ground-water flow directions	Error! Error! Unknown switch argument.✓	✓	Error! Error! Unknown switch argument.✓	✓
Monitoring ground-water and surface-water interaction	Error! Error! Unknown switch argument.✓	✓	Error! Error! Unknown switch argument.✓	✓

Groundwater resource assessment			Error! Error! Unknown switch argument.✓	✓
Numerical (computer) modelling of ground-water flow or contaminant transport	Error!Error! Unknown switch argument.✓	✓	Error! Error! Unknown switch argument.✓	✓

Table 5.1: Typical length of water-level-data collection as a function of the intended use of the data.

5.4 CURRENT WATER LEVEL MEASURING FREQUENCY

In India the water level monitoring frequency have been common for all the different requirements, and the measurements restricted to few times in a year. These times are selected coinciding with pre-monsoon, monsoon, post-monsoon and winter seasons. Limited water level data originating from extensive monitoring networks has been used for getting a very broad regional picture of the groundwater regime. It is presumed that these water levels represent the troughs and peaks of the water table hydrograph. However, many a time these data have been too sparse to yield reliable and credible water table hydrograph.

Today, when groundwater development has increased far too rapidly, there is a need for better understanding of the localised changes in groundwater behaviour between seasons and between different aquifer systems within an area. The water level measurements need to be taken as frequently as needed to depict the fluctuations realistically. If the measurements are not frequent then the rise and fall of water levels are invariably underestimated. Typical characteristics of the hydrogeological system will then be totally missed.

Currently, two types of monitoring are being carried out:

- periodic monitoring, and
- continuous monitoring.

5.5 PERIODIC MONITORING

Periodic ground-water-level measurements are made at scheduled intervals (daily, weekly, fortnight, monthly, or season). Periodic water-level measurements are usually carried out through manual measurement techniques, such as chalked metal tapes or water level indicator. The most popular periodic monitoring frequency in India by the groundwater agencies is either monthly or seasonal. In many situations, periodic monitoring tends to miss hydraulic responses of aquifers to short-term stresses, which may occur between measurements, also, extreme water-level fluctuations cannot be determined with certainty. The trends revealed from these measurements are likely to be biased by the choice of measurement frequency. The frequency of seasonal monitoring should be based on the monitoring objective. The limitations of the seasonal observations should be well understood before they are used for any major interpretations.

Synoptic water-level measurements are a special type of periodic measurement, in which water levels in all the monitoring wells within a homogenous hydrogeologic/drainage unit are measured within a relatively short period. Synoptic water-level measurements provide a “snapshot” of heads in an aquifer. Synoptic measurements should be taken, when data are needed for mapping the altitude of

the water table or potentiometric surface, determining hydraulic gradients, or defining the physical boundaries of an aquifer. Regional synoptic measurements made on an annual or multiyear basis should be used as part of long-term monitoring, to complement more frequent measurements made from smaller number of wells.

5.6 CONTINUOUS MONITORING

Continuous monitoring is near real time monitoring, that is usually established in a certain fraction of wells within the monitoring network. The spatial coverage of continuous monitoring should be so selected to be able to provide considerable insight into changes that occur during those intervals when data from the larger network are unavailable. Considerable care must be taken to ensure that this subset provides data that are as representative of changing aquifer conditions as possible. The subset of wells selected need to:

- provide unambiguous and quantitative real-time information on unique and potentially damaging ground-water level events that are occurring and signal these events as early as possible;
- represent ground-water conditions over a substantial area of the aquifer;
- monitor specific areas where the aquifer may be more susceptible to water-level related problems, and
- provide information that aids in the assessment of saltwater intrusion in those areas of the aquifer where such considerations are relevant.

Continuous monitoring or near continuous monitoring is usually carried out using Digital Water Level Recorders (DWLR), which are programmed to make measurements at a specified frequency. The continuous monitoring frequency should be such that it provides the highest level of resolution of water-level fluctuations. Hydrographs constructed from such measurements should be useful to accurately identify the effects of various stresses on the aquifer system and to provide the most accurate estimates of maximum and minimum water-level fluctuations in aquifers.

A six hourly water-level hydrograph from a piezometer in Rotarypuram, in Anantapur district of Andhra Pradesh and hydrographs that would have been obtained for the same piezometer if measurements had been made only monthly or quarterly are shown in Figure 5.1. Comparing the effects of different measurement frequencies on the hydrographs illustrates several features. First, monthly/quarterly periodic water-level measurements for this piezometer generally are adequate to discern overall seasonal patterns in water levels and long-term trends but miss some short-term effects from pumping or recharge. Second, unless periodic measurements correspond with regular patterns of seasonal variability of water levels, it can be difficult or impossible to discern anything beyond simple long-term water-level trends. From the hydrographs it is also clear, that less frequent water-level measurements lead to lower estimates of the range of fluctuations in water levels and thereby the resource estimation.

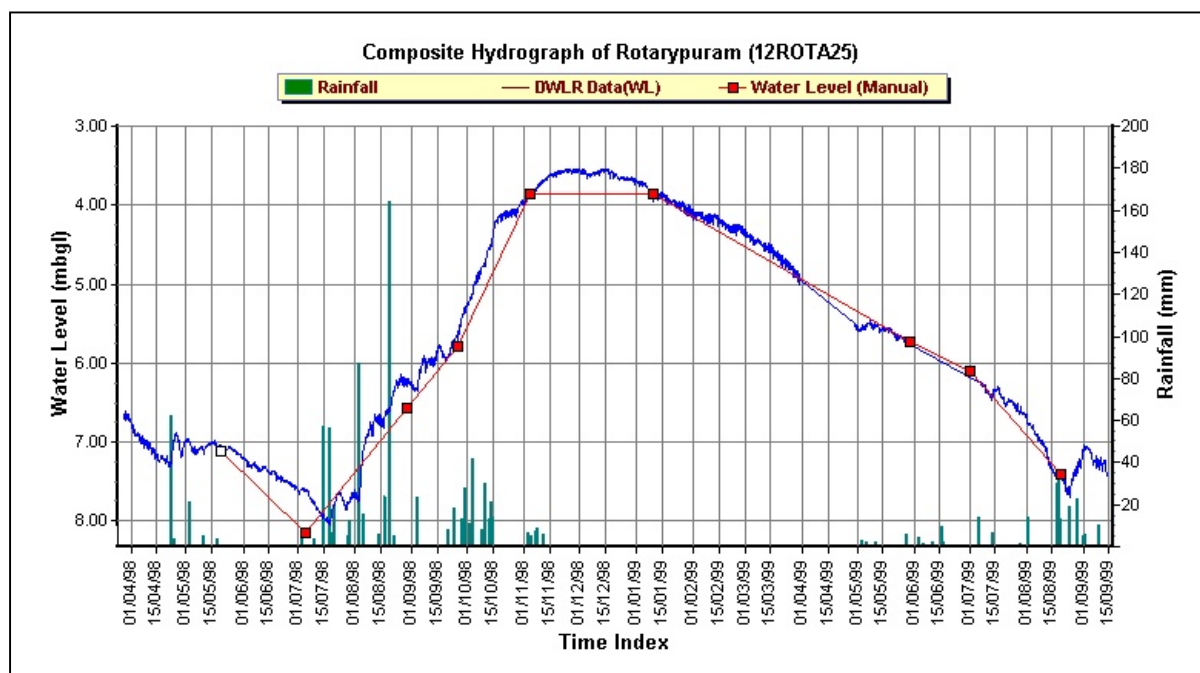

Figure 5.1: Six hourly continuous water level hydrograph compared with periodic monitoring

Continuous monitoring should be carried out only in those monitoring structures with good hydraulic connection with the aquifer so as to pick up the response of the aquifer to the different stresses. Continuous monitoring is very important to monitor fluctuations in ground-water levels during droughts and other critical periods, when hydraulic stresses change at relatively rapid rates. Continuous monitoring is essential in representative wells in coastal areas, areas influenced by surface water sources, like rivers, canals, irrigation tanks, aquifers being monitored for picking up crop cycles, meteorological cycles, etc. The continuous monitoring will help pick up daily maximum and minimum water levels and the nature of the short term and long term cyclicity critical for understanding the groundwater behaviour in these areas.

5.7 MONITORING FREQUENCY FOR GROUNDWATER RESOURCE ESTIMATION

Groundwater resource estimation requires data with intervals of events, seasons and details of cyclic phenomena. The frequency of monitoring for groundwater resource assessment should be such that there is an accurate estimation of the peaks and troughs. The monitoring frequency should be such that it shall permit construction of the *true hydrograph* of the water level. A true hydrograph can lead to estimation of the pre-monsoon (troughs) and the post-monsoon water table elevations (peaks), and their times of occurrences with a far higher resolution.

The monitoring periods should be such that the component of interest (peak/trough) is just fully generated. Any period less than that shall lead to an underestimation of the component. A longer period shall attenuate the predominance of the component and hence shall lead to a less reliable estimate of the component. Thus for estimating the rainfall recharge by carrying out water balance study of a rainy season, it shall be desirable to define a period during which the entire rainfall recharge just occurs. This period could be different from the period of the monsoon rainfall because of the inevitable time lag between the occurrence of the rainfall and the consequent recharge. The period must span between the discrete times of the lowest and the highest water table and not the start and end of the rainy season. Similarly, while estimating the specific yield by carrying out the water balance of the dry period, the duration of the water balance should incorporate the maximum possible decline from the viewpoint of activation of the specific yield. This implies that the duration should span between the discrete times of the highest and the lowest water table.

For optimal identification of the specific yield it is necessary to carry out the water balance study from the highest (peak) to the lowest (trough) water table. Similarly for optimal estimation of rainfall recharge, it is necessary to carry out the water balance study from the lowest (trough) to the highest (peak) water table. This calls for an identification of the peaks and troughs and their times of occurrence.

Continuous monitoring of representative monitoring structures is desirable for groundwater resource assessment. The actual monitoring frequency should be guided by the local hydrogeological settings and groundwater development pattern. Figure 5.3 shows a hydrograph comparing continuous monitoring with seasonal monitoring.

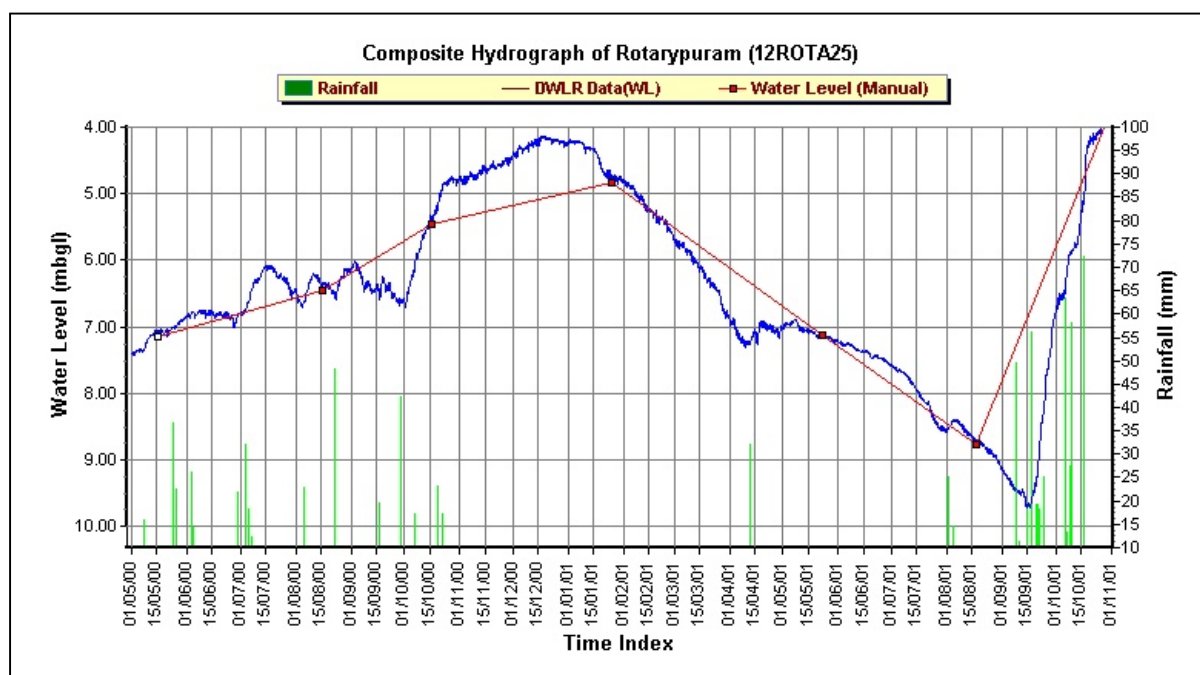

Figure 5.2: Hydrograph comparing the water level data emerging from continuous monitoring (every six hours) with seasonal monitoring (4 measurements/ year). The hydrograph of the manually monitored data underestimates the peak and trough while completely missing some major events.

5.8 MONITORING FREQUENCY IN DROUGHT PRONE AREAS

Monitoring of water levels in droughts prone areas is essentially for understanding the rate of groundwater decline for different draft and meteorological conditions. The requirement would be to anticipate the deepest water level in advance and make it available to the planners and managers to prepare them for appropriate responses. The frequency of monitoring should be such that it shall permit the estimation of the troughs and predict the impact of overdrafts on the aquifer system.

The impact of different rainfall intensities as groundwater recharge for different soil moisture deficit scenarios also need to be accurately understood. The time lag between the occurrence of the rainfall and the consequent recharge in different geological, geomorphologic and land use system should be reflected through the monitoring. The monitoring should be such that the data emerging should help in designing appropriate watershed programmes and recharge structures.

Continuous monitoring is desirable in the drought prone areas. The monitoring frequency should be such that the hydrograph constructed from such measurements should accurately identify the effects of all the different stresses imposed on the aquifer system. The monitoring frequency should enable accurate estimation of deepest water level as well as pick up the recharge response for different

rainfall events. The continuous monitoring frequency should also help pick up daily maximum and minimum water levels and short term and long term cyclicity of the groundwater stress. Figure 5.3 shows a typical hydrograph with continuous monitoring in a drought prone area.

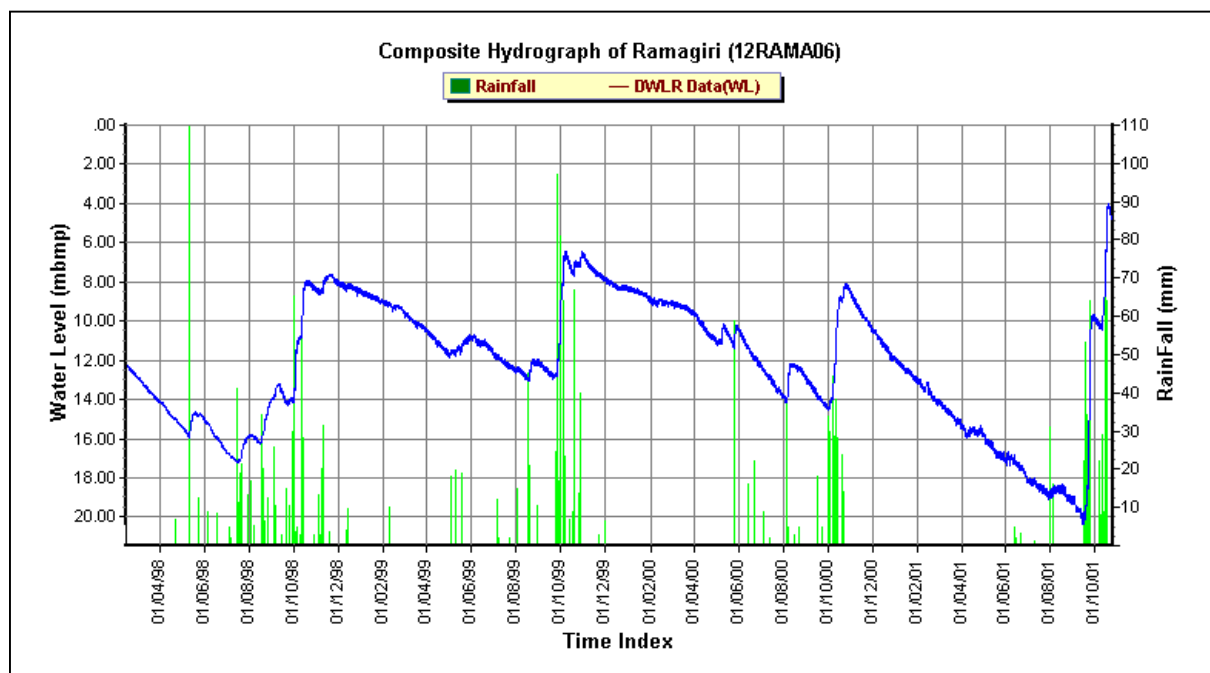

Figure 5.3: Hydrograph showing water level data emerging from continuous monitoring (every six hours) in a drought prone area showing stress periods with steady decline in water levels for 6-8 months followed by recharge phase leading to steep rise in water levels during storm events.

5.9 MONITORING FREQUENCY IN IRRIGATED CANAL COMMANDS

Monitoring of groundwater levels in canal command areas require high resolution to identify periods of water logging. The water table rise and decline are related to canal opening and closure, which should become clearly visible in the hydrograph. Clear understanding of the periods of water logging conditions and the rate of rise and fall of waters can lead to good understanding of the return flow from irrigation from surface water systems. Seepage from canal may recharge the water table and may lead to its rise in the vicinity of the canal. However, there would be a time lag between the beginning of the discharge in the canal and the rise. The rise may sustain for a while even after the closure of the canal discharge. The monitoring frequency should also identify such time lags. Figure 5.4 shows a hydrograph from a Canal Command area showing rising water level trend.

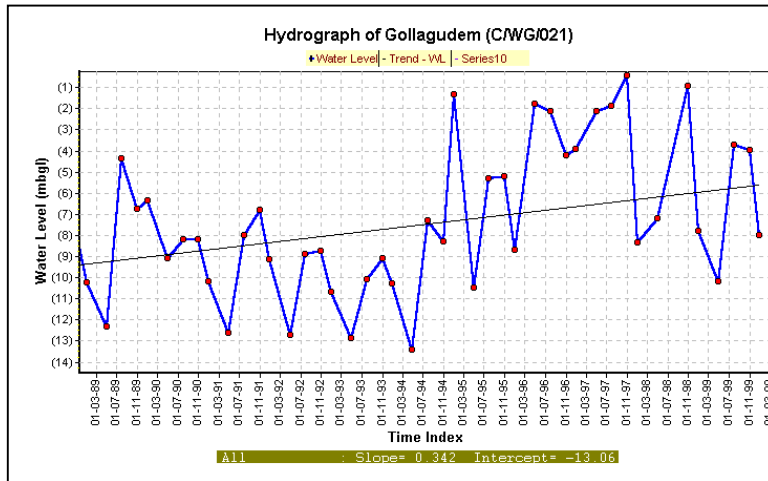

Figure 5.4: Hydrograph showing continuous monitoring in a canal command area; the water level rise coincides with the canal opening, the water logged periods and water level decline after canal closure .

5.10 MONITORING FREQUENCY IN OVER EXPLOITED AREAS

Over-exploited areas are characterised by falling annual peaks and troughs. In such areas the monitoring should be such that it can monitor accurately the shallowest and deepest water levels every year. Periodic monitoring might not always permit identification of the true hydrograph of water level displaying the peaks and troughs, in which case continuous monitoring will be a requirement. Figure 5.5 hydrograph is presented, showing a declining trend in an over-exploited area.

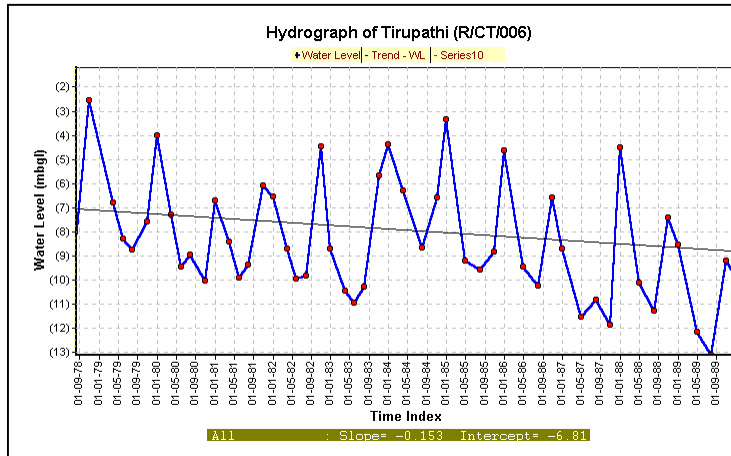

Figure 5.5: Hydrograph of periodic seasonal monitoring in a drought prone area, showing the declining water level trend over the years.

5.11 MONITORING FREQUENCY IN COASTAL AREAS

In coastal aquifers the times of daily peaks and troughs are to a large extent governed by the tidal cycle and the daily pumping schedules. The monitoring frequency in these areas should be such that it can pick the short-term hourly/ daily cycles, short-term cycles coinciding with the full moon and annual seasonal cycles. Figure 5.4 shows a hydrograph with typical repetitive cycles.

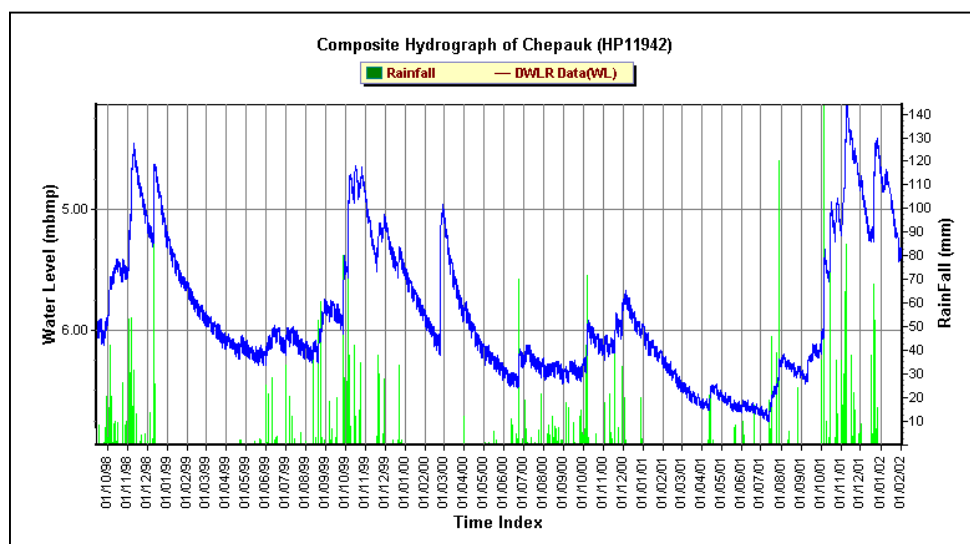

Figure 5.6: Hydrograph continuous monitoring in a monitoring structure close to the coast showing the daily pumping cycles, short-term cycles coinciding with the full moon and annual seasonal cycles.

5.12 MONITORING FREQUENCY OF OTHER SUPPORTING HYDROLOGIC DATA

Commonly overlooked is the need to collect other types of hydrologic information as part of a water-level monitoring program. Meteorological data, such as precipitation data, aid in the interpretation of the water-level changes in the observation wells. Where observation wells are located in alluvial aquifers or other aquifers that have a strong hydraulic connection to a stream or lake, hydrologic data, such as stream discharge or stage, are useful in examining the interaction between groundwater and surface water. Meteorological and streamflow data commonly are available from other sources; but if not, some monitoring of variables such as streamflow and precipitation may be needed to supplement the water-level data, particularly in remote areas or in small watersheds.

Rainfall data have to be collected from the different raingauge stations influencing the monitoring structures. The raingauge stations are either maintained by the groundwater agencies or other departments. For systematic analysis of the DWLR hydrograph daily rainfall data is required. Stations equipped with an SRG, the monitoring frequency maintained is daily and the observations are recorded at 0830 hrs. In the west coast areas the observations are taken more frequently in case of heavy rainfall to avoid overflow due to limited capacity of the rain-gauge container. SRG's located at Full Climatic Stations are read twice daily at 0830 and 1730 hrs. Stations equipped with an autographic siphon type rain gauge, the recorder chart provide hourly values.

6 GROUNDWATER LEVEL MEASURING TECHNIQUES

6.1 MEASURING POINT

For all water level measurements, a fixed reference point must be established at the well head. This point usually is the top of the casing in the case of piezometers and top of the parapet wall in the case of dug wells. The reference point typically has to be surveyed to establish its position above sea level. To ensure the same reference points are used for all measurement, a notch or marking is made on the casing and the location of the point well documented in the records. For the sake of standardisation, it would be appropriate to locate the measuring point in the North-Eastern part of the piezometer or observation well. The locations and the altitudes of all observation wells should be accurately surveyed to establish horizontal and vertical datums for long-term data collection. Inaccurate datums are a major source of error for water-level measurements while generating contoured water-level or potentiometric-surface maps and in the calibration and sensitivity analysis of numerical ground-water models. Recent advances in the portability and operation of traditional surveying equipment, and in Global Positioning System (GPS) technology, have simplified the process of obtaining a fast, accurate survey of well location co-ordinates and datum.

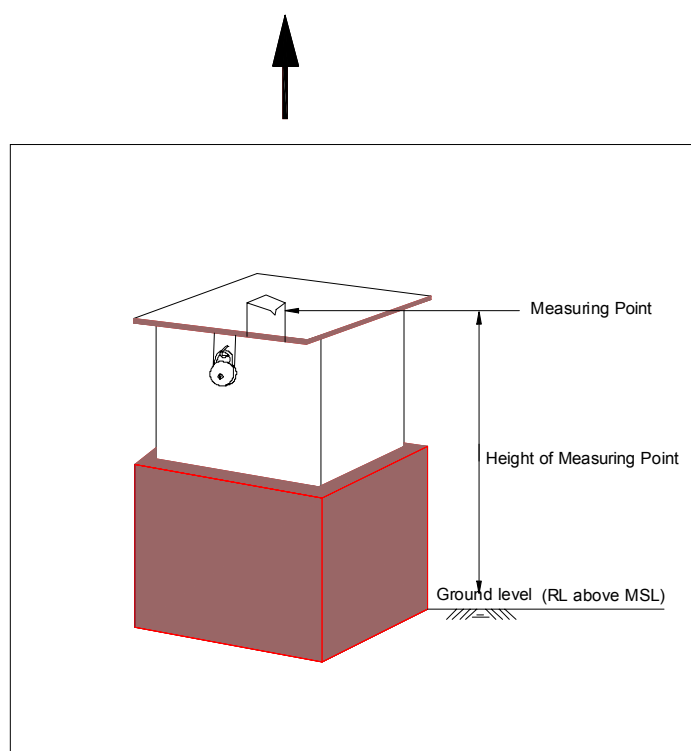

*Figure 6.1:
Piezometer cover showing measuring
point and ground level reference point*

6.2 GROUNDWATER LEVEL MEASURING TOOLS

Groundwater level measurements may be made with several types of measuring tapes or recorders including:

- chalked steel tape,
- electric measuring tape, and
- digital water level recorder.

The choice depends on several factors including the accuracy or ease of measurement required, type of structure (piezometer/open well) and pumping activity of nearby wells.

6.2.1 CHALCKED STEEL TAPE

The most accurate measurement can be obtained with a chalked steel tape as a steel tape has limited elasticity and when sufficient weight is attached, hangs vertically in the well. To a steel tape attach a weight preferably made of lead/stainless steel to the ring at the end of the tape. The weight ensures plumbness and permits feel for any obstructions. The weight should be attached in such a way that if it becomes lodged in the piezometer, the tape can still be pulled free.

The lower part of the tape should be coated with the chalk, and the tape lowered into the water until the lower part of the tape is submerged. The tape should be lowered slowly so that the contact of the weight with the water's surface can be heard. For piezometers with deep water levels, it may be necessary to approximately know the depth to water or to make several measurement attempts to ensure that the tape is not submerged below its chalked length. The tape should be held at the reference point and the tape position recorded. The depth to the water level below the reference point is determined by subtracting the length of wet tape (indicated by wet chalk) from the total length of tape lowered into the well. To lessen the possibility of computation errors, the "hold" position should be either on even metre. The measurement should be repeated to ensure its accuracy and that the measured water level is static. As a standard of good practice, the observer should make two measurements. If two measurements of static water levels made within a few minutes do not agree within about 1-2 mm (generally regarded as the practical limit of precision) in observation wells having a depth to water of less than 50 metres, then continue to measure until the reason for the lack of agreement is determined or until the results are shown to be reliable. Where water is dripping into the hole or covering its wall, it may be impossible to get a good watermark on the chalked tape.

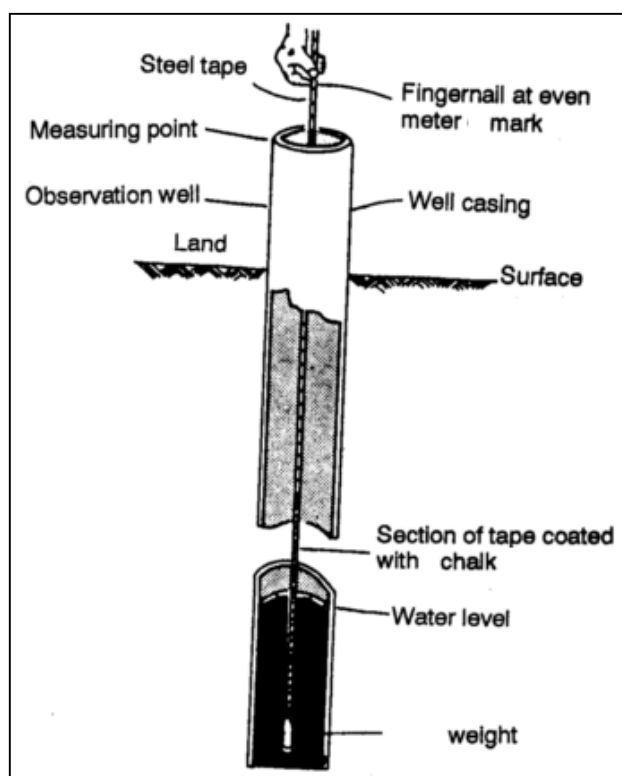

Figure 6.2:
Piezometer section showing water level measurement using Chalk steel tape method

Submergence of the weight and tape may temporarily cause a water-level rise in wells or piezometers having very small diameters. This effect can be significant if the piezometer is in materials of very low hydraulic conductivity. In summer conditions, it may be desirable to pull the chalked part of the tape

rapidly to the surface before the wetted part of the tape dries and read the watermark before rewinding the tape onto the reel. To do this pull the tape from the well by hand rapidly and do not allow the tape to become kinked.

After each water level measurement, the portion of the tape that was wetted should be cleaned to avoid confusion with the next measurement as well as to prevent formation of coating of rust.

6.2.2 ELECTRIC MEASURING TAPE

Currently, a number of electrical measuring tapes are in use by the different groundwater agencies. It is necessary to understand the working principle of the measuring tapes. Most operate on the principle that a circuit, is completed when two electrodes are immersed in water. Ordinarily, two-conductor electric tapes are 50 -100 metres long mounted on a hand-cranked reel that contains space for the batteries and some device for signalling when the circuit is closed. The electrodes are in a weighted probe that keeps the tape taut while providing some shielding of the electrodes against false indications as the probe is being lowered into the hole.



*Figure 6.3:
Electrical water level measurement tape*

The tape should be lowered slowly in the piezometer and when the electrode contacts the water surface, a current flows through the tape circuit, which will then be indicated by deflection in the ammeter-needle or light, or audible signal. The tape should be held against the reference point and the reading noted directly from the tape as depth to water. Because the tape can be easily bent and the weight is often less than that used on steel tapes, the accuracy of electric tapes may be considered to be less accurate. The tape should be periodically calibrated against a steel tape and if several electric tapes are used they should all be calibrated against a reference steel tape.

Though electric tapes are less cumbersome and inconvenient to use than the wetted-tape method, and they normally give less accurate results, in some situations, however, they are superior. Where water is dripping into the hole or covering its walls, it may be impossible to get a good watermark on the chalked tape. In piezometers that are being pumped, particularly with large-discharge pumps, the splashing of the water surface makes consistent results by the wetted-tape method impossible. Where a series of measurements are needed in quick succession, such as in aquifer tests, electric tapes have the advantage of not having to be removed from the well for each reading. Electric tapes are also safer to use in pumping wells because the water is sensed as soon as the probe reaches the water surface and there is less danger of lowering the tape into the pump impellers.

Independent electric tape measurements of static water levels using the same tape should agree within 2 mm for depths of less than 50 m. At greater depths, independent measurements may not be this close.

6.2.3 DIGITAL WATER LEVEL RECORDER

Long term or near-continuous measurement of ground-water levels should be done with the use of Digital Water Level Recorders (DWLR). A DWLR allows rapid and accurate measurement of water pressure. Unless static water levels are shallow, DWLR should be the preferred method of continuous water level measurement, both from efficiency and accuracy point of view. The DWLR chosen for use should be very accurate and rugged. They should have superior long-term operation with minimal drift over time. DWLR uses pressure transducers for measuring the pressure. The pressure transducer use silicon-based strain gages that generate an electric current. The current is calibrated to pressure which can be related to water levels. Pressure transducers, generally uses vented cables to eliminate response to atmospheric pressure changes Accuracy generally is 0.01-0.1% of the full-scale range. Pressure transducers are temperature sensitive and cables are subject to stretching with time. Thus, the transducers must be both factory and field calibrated.



*Figure 6.4:
Photograph of components of DWLR
showing the pressure sensor, cable and
connector*

Install DWLRs on piezometers after a good understanding of the deepest water level in summer and the shallowest water level. Choose the appropriate range of DWLR. DWLR should be selected on the basis of expected water-level change. The smallest acceptable range provides the greatest measurement resolution. The input parameters to be entered at the time of installation of the DWLR should be accurate. The depth of the piezometer and the static water level when not accurate can result in erroneous water level data. Kinks and bends in the cable should be avoided. To measure water levels, select the appropriate transducer. Submerge the transducer to about mid-monitoring range. Allow it to acclimatise to ground-water temperature for about 20 minutes. Set the factory prescribed range, linearity, and offset for proper quadratic conversion of the electric signal. Wrap a small piece of electrical tape on the transducer cable at the top of the well casing. Using a measuring tape position vertically on top of the well casing, raise the cable and transducer 0.3 m, check the water level change using the data logger. Raise the cable another 0.3 m. Check water level change again. Lower the cable 0.3 m, check change and repeat. Each measurement should be within about 1 mm of the 0.3 m raising increments. Secure the cable to the well head, so it will not slip and the reference tape can be used to monitor possible slippage. Measure the depth to water with a steel or electric tape and set the reference depth in the data logger (0.00 to record relative change or depth to water or water-level altitude). Periodically, check the transducer reading with tape measurement to

monitor electronic drift or slippage of the cable. If drift or slippage occurs, reset the position and datum and adjust the record accordingly (prorating change in position/depth reading?).

Wherever the continuous records of water levels have been obtained from monitoring observation wells, water changes during pumping tests and slug tests, the results have been very informative.

6.3 POTENTIAL INACCURACIES IN WATER-LEVEL MEASUREMENT

Good quality-assurance practices help to maintain the accuracy and precision of water-level measurements. This ensures that observation wells reflect conditions in the aquifer being monitored, and provide data that can be relied upon for many intended uses. Therefore, field and office practices that will provide the needed levels of quality assurance for water-level data should be carefully thought out and consistently employed.

Some important field practices that will ensure the quality of ground-water-level data include:

- the establishment of permanent datums (reference points for water-level measurements),
- periodic inspection of the observation structure, and
- periodic hydraulic testing of the piezometer to ensure its communication with the aquifer.

Existing observation wells/piezometers used for water level monitoring should be carefully examined to ensure that no construction defects are present that might affect the accuracy of water-level measurements. This may entail at times the use of downhole logging tools to verify the well screen position and well construction. Over time, silting, corrosion, or bacterial growth may adversely affect the way the well responds to changes in the aquifer. Hydraulic tests should be repeated periodically to ensure that hydraulic communication between the well and the aquifer remains optimal and that the hydraulic response of the well reflects water level (head) fluctuations in the aquifer as accurately as possible.

Some potential causes inaccuracies in water level measurements are:

- faulty procedures and (or) measuring tapes,
- incorrect measurement point used ,
- water levels not "static",
- depth of Well is greater than the measuring tape, and
- wrong or poor well design.

To help maintain quality assurance, the results of hydraulic tests should be stored in the database after every testing. Recent water-level measurements should be compared with previous measurements made under similar hydrologic conditions to identify potential anomalies in water-level fluctuations that may indicate a malfunctioning of the measuring equipment or a defect in the observation-well construction.

7 EQUIPMENT SPECIFICATIONS

7.1 INTRODUCTION

For the development of comprehensive and user friendly databases it is important to pay special attention to the standardisation of procedures and equipment for collecting this data. It is important, prior to investing in geo-hydrologic equipment, particularly DWLRs, a clear, detailed definition of user requirements appropriate for Indian conditions is prepared. Also, the specifications shall be, where necessary, site specific.

It is important that appropriate instruments are acquired and implemented, wherever required. When choosing equipment **the overall cost of the ownership over the life of the system needs to be carefully considered**. The initial capital cost outlay needs to be balanced against the expected life of the product, the operating and maintenance costs, the risk of data loss plus any benefits such as convenience or time savings (manpower costs) provided during the operating life of the system. The capital cost of a system may be the lowest. However, higher operating, maintenance and other costs over a number of years may push the overall cost of ownership higher than an alternative system, which has a greater capital cost of purchase.

It is very important that the manufacturer's specifications and jargon are fully understood prior to evaluating tenders or bids for the supply of the equipment. Those suppliers who do not meet the specification, should not be considered. It is also very important that the instruments and equipment under consideration should have a well-proven 'track record' under similar conditions to those in which they are to be used. In addition manufacturers should be able to demonstrate that they have good manufacturing, quality assurance and calibration facilities and they have a high level of quality assurance procedures in place.

7.2 INSTRUMENT AND EQUIPMENT SPECIFICATIONS

The Specifications are covered in the 'Equipment Specification Groundwater' as a separate Volume. This section provides some guidance on the type of information to provide in the specification for Digital Water Level Recorder (Pressure sensor type)

The specifications on the DWLR should include requirement on the sensor, recorder, electronic enclosures, cable and data retrieval system. Items to be considered are listed below. Furthermore, items on the quality of the manufacturer, installation, acceptance, maintenance, etc., should be included. These items are elaborated in next section:

Items to be considered in the specifications for a digital water level recorder (Pressure sensor type):

- **Sensor**
 - Measuring range;
 - Accuracy;
 - Size/weight;
 - Long term stability;
 - Level of protection - IP level of protection;
 - Moisture ingress protection;
 - Corrosion protection.

- **Recorder (or Data Logger)**
 - ADC and Storage resolution;
 - Measuring intervals;
 - Memory;
 - Back-up;
 - Storage capacity;
 - Parameters to be recorded and stored e.g. date, level, time;
 - Clock;
 - Power supply and battery life;
 - Operating temperature range;
 - Interface for data communication.
- **Electronics enclosure**
 - Material,
 - level of environmental/ingress protection;
 - dimensions;
 - connectors;
 - corrosion resistance.
- **Cable specifications**
- **Data retrieval system**
 - Type;
 - Capability
 - LCD display required;
 - capacity to offload data
 - power supply;
 - back-up battery;
 - operating temperature, and humidity ranges
 - suitability, compatibility and user friendliness of software.

7.3 OTHER ITEMS TO BE INCLUDED IN THE SPECIFICATIONS

Other items to be included in the specifications include:

- company reputation, facilities, authentication and accreditation;
- installation, commissioning and training;
- acceptance;
- warranty, service, maintenance and spare parts, and
- tender evaluation criteria;

These items are elaborated below.

Company Reputation, Facilities, Authentication and Accreditation

It is very important, particularly for large orders that the company concerned has a good, proven track record with the equipment they are selling. Therefore, in the tender specification the following information should be requested:

- Company background - history, size, how long has it been manufacturing and/or supplying the very instrument concerned, back up support facilities in India. Official published company accounts for the last three years is sometimes a useful indicator of company credibility.
- Project profiles of the same equipment supplied over the last five years for similar applications in same environmental conditions.
- A list of references i.e. names and addresses, telephone and fax numbers of previous customers, e-mail addresses where applicable. Experience has indicated that it is essential that these references are followed up.

- Details of instrument calibration facilities.
- Details of quality assurance procedures - have these been accredited, i.e. have these been approved by a recognised accreditation bureau/organisation?

Installation, commissioning and training

It is very important that the tender document/specification is clear about what is expected from the supplier on delivery. Is the contractor or supplier expected to undertake installation, commissioning and training? The more effort the supplier has to expend after delivery will generally have an increased knock-on effect on the overall cost. Conversely, particularly with modern, less familiar equipment, there is a danger if the equipment is to be installed by the purchasing organisation, that problems can occur. The amount of effort expended by the supplier at the installation stage is a function of the complexities of the equipment and the capabilities of the organisation concerned.

Acceptance

Irrespective of whether the equipment is to be installed by the supplier or not, it is important that some form of acceptance procedure is put in place. Even simple equipment should be inspected and approved on delivery. The acceptance routines will be instrument/equipment specific but should be more than just a number count against an inventory. Other instruments such as DWLRs will require more complex acceptance procedures. As a general policy, all instruments, equipment, software deliverables should be submitted to an acceptance protocol. Where appropriate, instruments will only be accepted with the necessary calibration certificates and other supporting documentation. The quality of the finished product will be up to the standard stated in both the tender and supplier's specifications. It should be made clear in the tender specification that the supplier will not receive full or final payment, depending on the agreed payment schedule until such time as a formal acceptance procedure has been successfully completed.

Warranty, service, maintenance and spare parts

Some equipment of the quality required is not readily available, on local markets. Therefore, equipment might have to be purchased from elsewhere in the country or internationally. It should be clearly spelt out in the tender document, what the successful supplier will be expected to provide in the way of back-up services.

Generally, it should be expected that the supplier will have an office or fully trained Agent within each State where his equipment is installed. This office should be able to provide adequate support facilities, including replacement instruments, spare parts, servicing, maintenance contracts and further training. Most reputable manufacturers will offer a 12 months full warranty period or more and sometimes a further two years of reduced warranty, but this should be confirmed.

Tender evaluation criteria

It should be made clear in the tender documents that **only equipment meeting the specifications in their entirety will be considered**. Also, it should be clearly emphasised, that purchase cost will not necessarily be the overriding factor in the evaluation of tenders. Moreover, any bid, missing parts of specifications or not responding to all the specification details requested, whether deliberately or not, should be treated as non-compliant with the tender requirements. A manufacturer/vendor having a poor performing record or offering a product that is poorly performing under Indian conditions may be thoroughly scrutinised.

7.4 INTERPRETATION OF EQUIPMENT SPECIFICATION

The interpretation of manufacturer's specifications for conventional equipment is relatively straight forward. However, the advent of modern electronic PC based instruments, new terminology have to be used.

Contemplating the use of electronics-based technology takes many geo-hydrologists into unfamiliar territory. There is likely to be rather more to do than simply make a decision regarding "most appropriate technology for the application". Even if that choice is straightforward, there will be competing products to be considered, each hailed by its salesman as (a) totally appropriate to your application and (b) the best and most cost-effective in its class. Some unfamiliar terms may be encountered in product literature that, though they may be intended to be informative regarding the performance that the manufacturer is claiming for his device, may sometimes be selectively so. "Specmanship" is a highly developed art, that seeks predominantly to highlight the virtues that the supplier sees in his product, while drawing as little attention as is decently possible to its limitations.

All trades and professions use jargon as a convenient shorthand that is totally meaningful to the initiated. To outsiders, it may be at best confusing, at worst incomprehensible. A typical **Product Specification** or **Calibration Certificate** for a DWLR of the pressure sensor type might contain such terms as:

- FSO (Full Scale Output) or FRO (Full Range Output)
- BSL (Best Straight Line)
- Hysteresis
- Linearity
- Temperature Error Band
- Thermal Zero Shift
- Thermal Span Shift
- Compensated Temperature Range
- Zero Offset
- IP standards

There may also be unfamiliar measurement concepts such as the "**Bar**" to be grasped, as a unit of measure for pressure, coupled with a need to be able to interpret this as "**Depth of Water**". There will also be "**Gauge Pressure**" to be distinguished from "**Absolute Pressure**", if Specifications are to be fully understood. For this reason the terms listed above have been defined and briefly explained in the section on DWLR's of the pressure sensor type, in Section 6.1.2 of this manual. Whenever possible the specifications for instruments, which have not been used before, should be interpreted by an experienced hydrometric instruments specialist with an electronics and/or physics background.

7.5 EVALUATION OF SPECIFICATIONS

The evaluation of the specifications comprise the following items:

- Technical specifications;
- Company background and reputation, qualification criteria;
- Quality assurance, certification and accreditation, and
- Installation, commissioning, training and back-up support.

These items are dealt with below.

Technical specifications

In order to assist with the evaluation of the Technical Specifications it is recommended that a standard evaluation form is prepared, which can be completed for each tenderer. This form should list the various attributes specified in the tender document, the required specification and the specification of the suppliers equipment. This is particularly important for evaluating specifications for equipment of an electronic nature such as DWLR's. The form should be used to assist with the evaluation process. Where equipment fails to meet the tender specification, this should be clearly indicated on the form.

The form is divided into 11 main sections, namely:

1. General information;
2. Pressure Measurement;
3. Data logger;
4. Electronics enclosure;
5. Cable;
6. Data Retrieval System (DRS);
7. PC utility software;
8. DWLR spares;
9. DRS spares;
10. Maintenance;
11. Training;
12. Any special features.

Only instruments or equipment which **fully meet the requirements** of the tender specifications should be considered for purchase.

Company background and reputation

The organisation tendering for the supply of equipment will be asked to provide background information such as quality assurance procedures, calibration facilities, financial standing, details of recent sales and installation of equipment particularly in similar hydro-meteorological conditions to those experienced in Peninsular India. Every attempt should be made to authenticate this information, particularly if the company concerned is unknown or not well known to the organisation letting the tender. Some of the Company's quoted references should be contacted at random to obtain an independent opinion on the performance of the equipment based on the experiences of other users. The financial stability of the company and its potential longevity are also important considerations. No organisation wishes to commit themselves to a large order of hydrometric equipment, only to find that the company concerned is dissolved shortly after delivery, resulting in a cessation of back-up support.

Quality assurance, certification and accreditation

Prior to placing a large order for DWLR's or similar electronic based hydrometric equipment, the organisation letting the tender, should satisfy themselves that the company concerned has adequate quality assurance procedures already in place. In some countries, suppliers will have manufacturing and calibration facilities, which will have been certified by an appropriate independent bureau or organisation to comply with a traceable national or international standard. In such circumstances the buyer should be reasonably confident that the quality required will be achieved. However, in India to date, despite the presence of a well-established standards bureau, such procedures are not widely established.

Until such procedures are in place, particularly where large orders of equipment are involved, some form of inspection procedure should be established. In the first instance suppliers will be asked at the tender stage to indicate their quality assurance and calibration procedures. In particular with regard to the latter it is important that they specify how the instrument calibration is undertaken and who undertakes this work if it is not done in-house.

If a company is one of the favourites to be awarded an equipment tender, then consideration should be given to inspecting their manufacturing and calibration facilities. This inspection should be undertaken by an experienced instrument specialist with electronics' background.

If some key instrument components are bought in from an external source (third party), attempts should be made to also ascertain the standing of that company and their quality assurance procedures.

Installation, commissioning, training and back-up support

Care should be taken to ensure that the supplier has committed himself to the necessary installation, commissioning and training requirements. The suppliers concerned should clearly demonstrate that they have the necessary staff to complete the work in the time-scales available. The locality of key staff should be established and supported with CVs and technical certificates where appropriate. The supplier should provide documentary evidence that he has an established office/agent within a reasonable distance/travel time from where the equipment is to be installed.

7.6 INSTALLATION CRITERIA

The pressure sensor type DWLR consists of three main parts:

1. The sensor assembly has to be lowered into the piezometer and installed at an appropriate depth, keeping in mind the anticipated water level fluctuations.
2. The connecting cable, communicates with the pressure sensor and the data logger and carries the atmospheric vent tube.
3. The logger, depending on make, can either be integrated with the sensor or be on the end of the cable above the water.

Installation guidelines

Some general installation guidelines are as follows:

- a) Pressure sensors do not require stilling wells. The pressure sensor hangs from a permanent fixing at the top of the piezometer.
- b) The diameter of a typical pressure sensor very rarely exceeds 50 mm. Keeping in mind the diameter of the sensor and similar logging tools, it is not necessary to have the diameter of the piezometer greater than 100 mm.
- c) Care must be taken to ensure that the position of the sensor relative to datum does not move. A clamping device at the top of the pipe on the wellhead should help keep the cable in position. Also, the cable might require time to fully stretch, i.e. cables usually arrive from the manufacturers coiled up.
- d) Some of the varieties require instrument housing, which have to be in the form of a weatherproof, secure instrument kiosk or in a box or in the protection tube. In such varieties, the logger should be housed in the protection box on the platform. A cable duct should be built into the plinth to allow the passage of the cable from the piezometer into the protection box. The kiosk should be weatherproofed to at least IP65 standard. Provision should be made to ensure that the

atmospheric vent tube is vented to atmosphere. Some models come with a hydrographic filter and desiccator of moisture protection to prevent ingress of water into the vent tube.

DWLR's require protection from moisture, dust, human interference and other factors. An international system of rating the amount of protection provided by instrument housings and enclosures is the IP system. This is summarised in Table 8.2 below.

Suitable internal dimensions for an instrument kiosk, depending on application could be 750 mm long x 500 mm wide x 500 mm high. This could sit on a concrete plinth 750 mm long x 500 mm wide x 1200 mm high. The instrument should be fixed to the plinth using internally accessible bolts and all opening should be sealed to prevent moisture ingress. This would provide adequate room to install and maintain the data logger including space for keeping the dessicator. A cable duct should be built into the plinth to allow the passage of the cable from the protection pipe into the recorder box.

When designing instrument housing provision should be made to prevent the ingress of moisture. The housing material should be made of GI sheet. The access door should be secured using an appropriate locking system and in some circumstances an additional locking strap can be fixed across the doorframe. Keyholes and padlocks should be provided with some form of protective cover.

8 DESIGN OF LITHO-SPECIFIC PIEZOMETERS

8.1 INTRODUCTION

The sub-surface may be considered as a sequence of geological formations in which groundwater occurs in the aquifers below the groundwater table. The quantity and quality of water occurring in the aquifers depend upon the mineralogical and geochemical conditions at the particular level. For proper accounting of groundwater resources, it is essential to monitor the water levels of independent aquifers. The water levels, which are not influenced by man made interventions, are an indicator of its resource potential at that point of time. For measuring the water levels from individual aquifers independent observation wells are constructed known as 'piezometers'.

In the construction of piezometers there is a need to consider different lithologies separately for identification of 'representative' piezometer sites. This has led to the introduction of the concept of lithology-specific-piezometers and hence referred to as 'Lithospecific Piezometers'. The construction of piezometers have followed strict administrative norms, based on which the depth of piezometer, depth of casing, development method and time, pumping details were fixed, adopting some norms rather than site specific requirements. Under these circumstances some piezometers should be considered as non- representative of the conditions that actually exist and could be providing erroneous results.

All water level monitoring programs depend on the design of piezometer. Decisions made about the design of the piezometer and its location are crucial to the water data collection program. Ideally, the piezometer constructed as part of the monitoring network need to provide data representative of the different geology, lithology and groundwater development environments. Decisions about the real-aerial distribution and depth of completion of piezometers should take into consideration the physical boundaries and geological complexity of the aquifers under study.

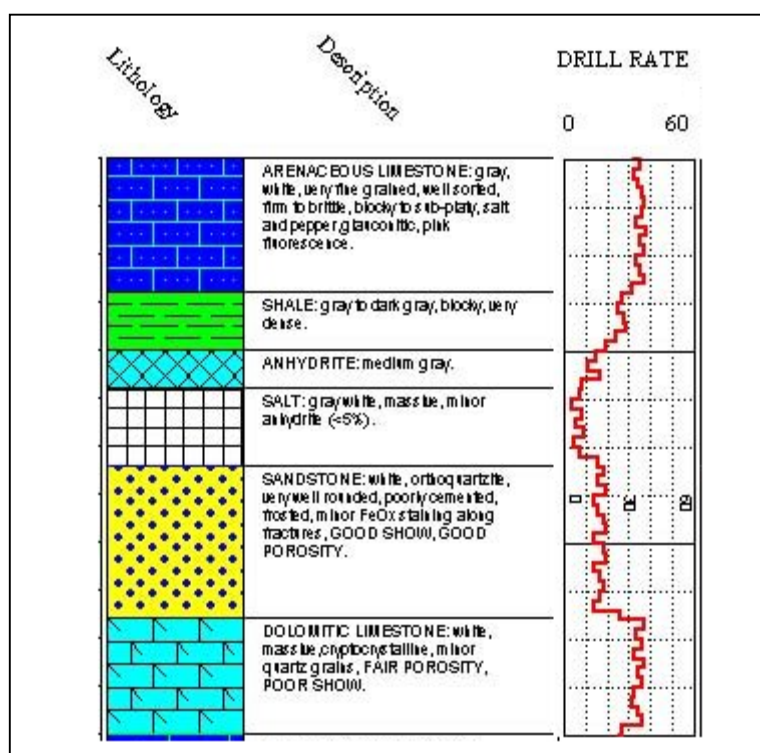

Figure 8.1: Typical Lithological description of drill cuttings in piezometer along with drill time log

Water level monitoring in complex geological and lithological environment may require measurements of water levels in multiple piezometers (nested) constructed at different depths tapping different aquifer units representing varied lithological and geological units in the area. Large geological/lithological units that extend beyond the state boundaries, require a network of piezometers that have representation beyond the states distributed among one or more states. One of the purposes of a network is to monitor ambient groundwater conditions or the effects of natural, climatic-induced hydrologic stresses. The piezometer network will require monitoring structures that are representative of regional geological, lithological units that have lateral and vertical continuity and represent the horizontal groundwater flow regime without any major gaps. The aim should be to ensure that there is no mixing up of information due to improper piezometer design. These and many other technical considerations pertinent to the actual design of a piezometer focussing on lithological and geological units is described in detail in the Field manual of this volume.

Geology and Lithology along with the mineralogy of the formations and groundwater flow have to be well understood before construction of any piezometer as well as for enabling proper site selection. Good understanding of the lithology of the area helps in designing the piezometer that enables the collection of accurate, authentic and precise water level data. Unbiased water levels can only reflect the true conditions in the aquifer being monitored and provide data that can be relied upon for many intended uses. In the construction of piezometers the principal objectives should be:

- to monitor the water levels and water quality of independent aquifers,
- to understand the relationship between different aquifers,
- to understand the hydraulic characteristics of different aquifers,
- to evaluate groundwater regime characteristics,
- to understand the regional flow characteristics, and
- to estimate groundwater resources availability.

The procedure and protocol for design and construction of piezometers shall be dictated by a number of factors including the geology, hydrogeology, lithology, and aquifer geometry not forgetting the objectives of the monitoring network. Thus prioritisation of the piezometer site as well as their design and construction should have a clear bearing and perception of the geology, lithology and aquifer type.

A geological map, lithological cross section, structural map, geomorphological map and geophysical survey reports are the important tools that will help in understanding the regional geological control on the groundwater system, which is an important consideration for the piezometer design. The observation wells/piezometers are usually of small diameter so as to accommodate the water level measuring device and the water-sampling pump. In unconsolidated formations, piezometers are provided with screens tapping the zone of interest, whereas in the consolidated rocks, piezometers are left open ended (uncased) beneath the loose soil/loose, over-burden, where the hole has to be provided with a casing. Upgrading/strengthening of the observation well network is a continuous process, which would require replacement of non-performing open wells with dedicated piezometers as well as construction of deep piezometers, to cover aquifers, that have not been previously monitored. Improvement in the density of the network would also arise with time. All this would involve construction of many more piezometers.

Reference is made to Volume 4, Field Manual, Part II for description of the construction of Lithospecific piezometer.

8.2 CHARACTERISTICS OF GEOLOGICAL FORMATIONS

In the construction of piezometers the geology, lithology and potential aquifers have to be properly understood before designing the piezometer and locating the site. For piezometers in the unconsolidated formations the geological materials are generally composed of sand, gravel, and clay

in various proportions, which occur as alternate layers. These formations are characterised by occurrence of primary (interstitial) pore spaces, which provide the main loci for storage, and movement of groundwater in the saturated zone. These materials are often assumed to behave as homogeneous and isotropic media. Yet, while designing the piezometers, it has to be kept in mind that homogeneous aquifers seldom occur in nature, with most aquifers being stratified to some degree. Because of the stratification, the hydraulic conductivity is found to differ in horizontal and vertical directions. The consolidated geological formations are devoid of primary porosity and permeability and the porous zones are the joints, fractures, faults and weathering, all resulting from secondary geological processes. In designing the piezometers the site selection assumes significance. Extensive field work involving geological/hydrogeological mapping, well inventory, geophysical surveys, test drilling need to be adopted before designing the piezometers. The different types of rocks i.e.; Crystalline rocks, Volcanic rocks, Clastic rocks and Carbonate rocks are dependent upon the degree of weathering and consolidation of fractures and fissures, which form the main flow conduits. Table 8.1 gives chief (consolidate) rock types and brief mode of occurrence of groundwater along with main features of occurrence of groundwater in each such formation.

Rock group	Rock types	Mode of occurrence	Main features important for groundwater occurrence
Crystalline rocks	Non-volcanic, igneous and metamorphic rocks, viz. granites, gneisses, schists, slates and phyllites, etc.	Large size massifs and plutons; regional metamorphic belts	Weathered horizon, fractures and lineaments with secondary porosity
Volcanic rocks	Basalts, andesites and rhyolites	Lava flows, at places interbedded with sedimentary beds	Fractures, vesicles and inter-flow sediments
Carbonate rocks	Limestones and dolomites	Mostly as chemical precipitates with varying admixtures of clastics in a layered sedimentary sequence	Fractures and solution cavities
Clastic rocks	Consolidated sandstones and shales	Interbedded sedimentary sequence	Inter-granular pore spaces and fractures

Table 8.1: *Hydro-geological classification of consolidated rocks (after Singhal and Gupta, 1999)*

The table shows that in contrast to the dominant primary porosity as a main feature for groundwater storage and movement in the unconsolidated formations, distinctly different hydro-geological frame work and flow features characterise the consolidated formations. The location and depth of the network observation wells and/or piezometers in such formations solely depends on the factors like the thickness of weathered zone, occurrence and characteristics of fractures and related hydrological features. In the case of uniformly and densely fractured rocks, the site selection and construction of such piezometers can be more or less similar to that in unconsolidated aquifers. However, in case of non-uniform fracturing, or in weathered zones of crystalline rocks, in carbonate aquifers with solution cavities and in basaltic aquifers with lava vesicles and tubes, the decision on the placement and depth of piezometers may require detailed studies of the hydrogeological situation.

8.3 GROUNDWATER MONITORING IN INDIA- AN HISTORICAL PERSPECTIVE

In 1968 the Central Groundwater Board started groundwater monitoring in all states as part of its activities with one observation well for each toposheet over the entire country. In all, 68 observation stations were established. Gradually with the need, more stations with lithological representation were also added. Mostly existing open wells owned by farmers or utilized for drinking water were included in such monitoring systems. With the operation of groundwater exploration and resource evaluation projects under UNDP and other added projects many observation network stations were established tapping shallow as well as deeper aquifers and amalgamated in the regular groundwater monitoring system. These were mostly on the basis of availability of wells as a sort of compromise and not on the basis of requirements at the specific locations. The water levels were measured initially twice, pre-monsoon and post monsoon period, which subsequently was converted to five times in a year falling in the months of January, March, May, August and November. From 1986 onwards 4 times in a year

is measured in the months of January, May, August and November. The data collected is utilised in specific reports for reporting on fluctuations and assessing water resources for the administrative divisions.

By 1972 the State Groundwater Departments also came into establishment and gradually groundwater monitoring was taken up. The density of network observation wells in alluvium was about one well per 100 km² on an arbitrary basis, while in hard rock it was more than that mostly in localised areas with groundwater development. Also, in exploratory areas with possible scope for groundwater development, monitoring was enhanced with addition of piezometers constructed for well field studies both in soft rock as well as hard rock areas under various national /international added projects in the country. At best these monitoring network stations served as indicators on baseline water level and water quality data. The information emanating from such networks has generally permitted conceptualisation of the groundwater system and its resource evaluation. These were in essence need-based piezometers rather than scientifically required for country monitoring system.

The data generated was mostly utilised for use in the internal report preparation by the departments and evaluation of groundwater resources for administrative units for the country as a whole. The depth to water level maps were prepared and interpreted for response of aquifers to various natural inputs from rainfall and canal/irrigation returns in terms of maps both for pre-monsoon and post-monsoon season. Also maps on water quality covering electrical conductivity and iso-chloride and total dissolved salts were prepared and interpreted.

The data generated were with certain inaccuracies as the monitoring wells were the same as those used for drinking water supply as well as irrigation. Consequently, exact water levels were not possible. Subsequently, with the advent of tube wells and bore wells in hard rock areas, which were fitted with electrically operated pumps, the water levels started declining and many of the dug wells went dry during summer period. As a result, lowest water level data could not be recorded. Some of the old wells went into disuse or were dumped with garbage and as such data collection was not possible, leading to data gaps.

8.4 MAINTENANCE OF PIEZOMETERS

The critical components making up a groundwater monitoring network are the observation wells (open dug wells/piezometers), digital water level recorders (DWLR's), water quality laboratories and the data processing and storage centre's. Historically, the hand dug open wells have been the single source for understanding groundwater dynamics. This has been further strengthened by the construction of piezometers, many of which have been equipped with DWLR's. Water level data emerging from the piezometers with DWLR's have started providing new insights on medium and short-term cycles of groundwater fluctuations, rainfall-recharge relationships, groundwater quality changes, and also enabled refinement of groundwater resources estimations. The optimum performance of the monitoring network needs to be ensured through well-defined Operation and Maintenance (O&M) practices. This calls for establishment of O&M procedures, supported with adequate budgets and trained manpower.

Generally, the maintenance of monitoring systems has often been neglected and deferred until the performance declined considerably or the system collapsed. This should not be allowed to happen with the new infrastructure created in the form of piezometers, DWLR's, water quality laboratories and the data centre's. Hence, there is a need for a well-defined O&M programme in place.

The focus should be on maintenance and upkeep of the water level monitoring networks. The different tasks that should be part of preventive maintenance, manpower and budgetary requirements, operational procedures should be clearly defined. The approach should be to adopt simple procedures for preventing declining performance of piezometers.

The detailed tasks with respect to O&M is discussed in detail in Volume 4, Field Manual, Part VIII.

9 REFERENCES

- **Mead D.W; 1919;** Hydrogeology; Mc Graw Hill Books, Co.
- **Freeze R.A. and J.A. Cherry,** Groundwater, Prentice Hall, Englewood Cliffs, N.J. 1979.
- **UN/ECE Task Force on Monitoring and Assessment, 1999.**
State of the art on monitoring and assessment of groundwater. Working Programme 1996/1999, Volume 4, Lelystad.
- **UN/ECE Task Force on Monitoring and Assessment, 2002.**
Guidelines on Monitoring and Assessment of Transboundary Groundwater. Working Programme 1996/1999, Lelystad.
- **Van Brach, M.J., 2001.**
Made to Measure Information Requirements and Groundwater Level Monitoring Networks. Doctoral Thesis Vrije Universiteit Amsterdam.